



INSTRUCTIONS

MODE D'EMPLOI

BEDIENUNGSANLEITUNG

MANUALE D'USO

MODO DE EMPLEO

DIAL GAUGE **E**

COMPARATEUR **F**

MESSUHR **D**

COMPARATORE **I**

COMPARADOR **S**

**Installing and replacing the battery
(or Power cable)**



Mise en place et remplacement de la
batterie (ou câble Power)

**Einbau und Austausch von Batterie
(oder Netzkabel)**

Installazione e sostituzione della batteria
(o del cavo di alimentazione)

**Colocación y sustitución de la batería
(o cable Power)**



No. 0  No. 0 (0,4x2,5mm) 



Battery / batterie / **batterie** / batteria / **bateria** : lithium 3V, type CR2032

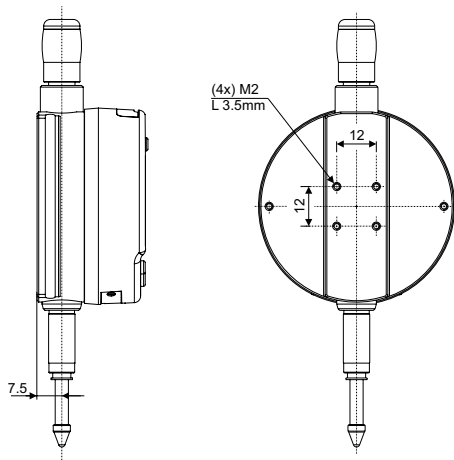

Diagram for rear fixings

Schéma de fixation arrière

Schema für die Befestigung hinten

Schema di fissaggio posteriore

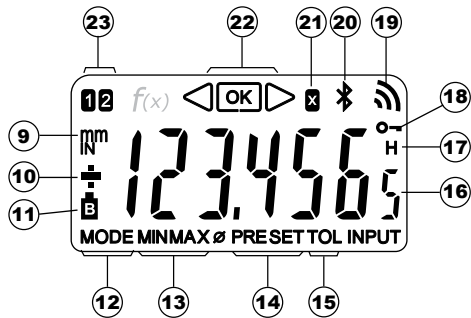
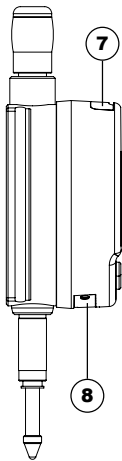
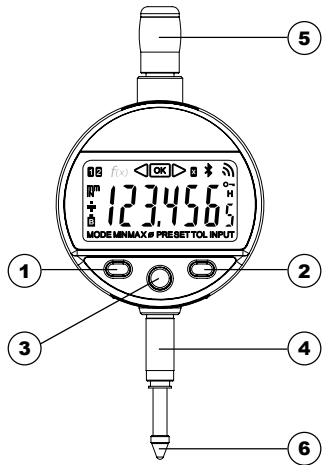

Esquema de fijación posterior



Description

1. MODE button
2. SET button
3. "Favourite" button
4. Clamping shaft $\varnothing 8$ or $3/8$ "
5. Lifting cap
6. Contact point $\varnothing 2 / M2.5$ or 4-48-UNF
7. Slot for Proximity cable
8. Slot for battery or Power Cable
9. Measurement units (mm/INCH)
10. +/- Indicator
11. Low battery
12. Mode menu display
13. MIN/MAX/DELTA mode
14. Preset mode
15. Tolerance mode
16. 6-digit display
17. Hold measured value
18. Button lock
19. Send data
20. *Bluetooth*® active (depending on version)
21. Multiplication factor
22. Tolerance indicators
23. Active reference

1 . Operating features of the instrument

-  The instrument has two operating modes: basic functions (direct access) and advanced functions. In addition to the configuration functions, 2 working reference functions can be accessed, in MIN, MAX and DELTA (TIR) mode, plus tolerance display or input of multiplication factor other than 1:1 (see chaps. 3 and 4)
-  The «favourite» key gives direct access to the function used most often (see chap. 7)
-  Sets a Preset value, reset the MIN/MAX mode, verifies a selection, and controls switching off the instrument. By default, SIS mode enables automatic switch-off with no loss of origin (see chap. 8)

- Personalising the functions

It is possible to activate or de-activate certain functions of the instrument via RS232 (see chap. 10)

- Data transmission parameters

4800Bds, 7 bits, even parity, 2 stop bits

2. Start

Press a button. When used for the first time, the instrument requests selection of the measurement unit required (mm or $inch$). Choose..... then measure.

For a *Bluetooth*® connection see chapter 5

3. Basic functions

Each short press on **MODE** gives direct access to the basic functions:

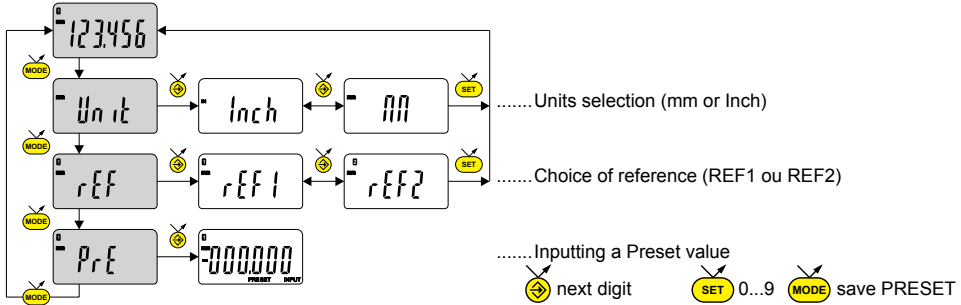

Note: It is possible to assign a different preset value to each of the 2 References. Similarly, different tolerance limits can be assigned to References 1 and 2.

4. Advanced functions

Prolonged pressure (>2s) on **MODE** gives access to the advanced functions. Then, each short press on **MODE** accesses the required function:

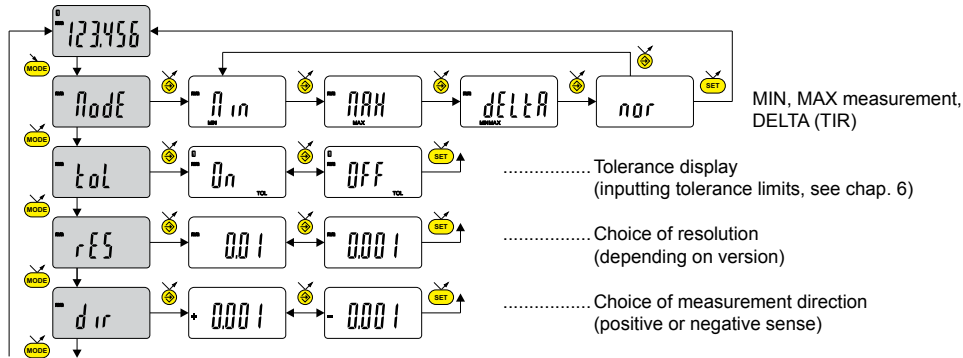

..... continuation

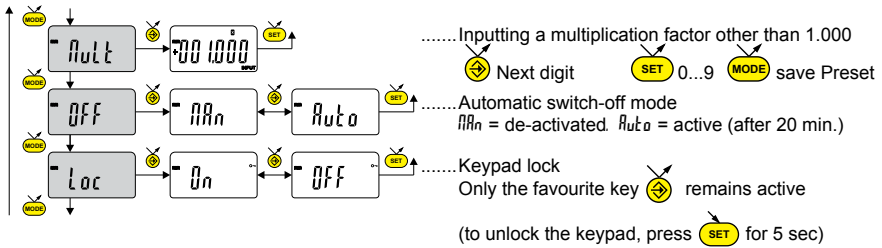

Note:

It is also possible to display the tolerance limits when the instrument is operating in MIN, MAX or DELTA (TIR) mode.

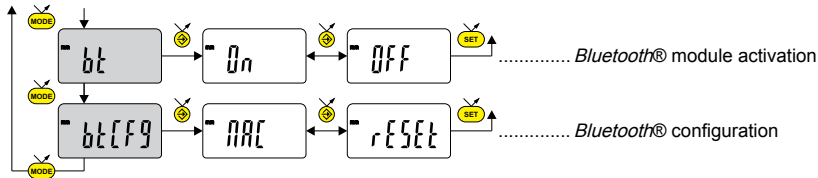

- If no tolerance limit has been defined by the user, the instrument will display the tolerance limit indicators ◀ ▶, but will not turn on the indicator lights (red - green - yellow)

..... continuation



5. Bluetooth® configuration

The connection procedure has been designed to be simple and is signalled by the following three states :

- 1° Symbol  off..... disconnected mode
- 2° Symbol  blinking..... advertising mode
- 3° Symbol  on..... connected mode

Connexion :

- 1° Activate *Bluetooth®* Smart compatible software and hardware (PC, measuring unit)
- 2° Start the instrument. By default the *Bluetooth®* module is active and the instrument is available for connection during 120s (advertising mode)

3° As soon as the device is detected, a connection is established automatically. If no connection is established during 120s, reactivate the *Bluetooth®* module using the *bt / On* menu.

4° Instrument is ready to communicate (connected mode)

Pairing:

Pairing with master is automatically done at first connection.

To connect the instrument to a new master (new pairing), it is necessary to clear all pairing information on the instrument using the *bt [F9] / rESEt* menu.

5.1 *Bluetooth®* specifications

Radio frequency	2.4Ghz
Security	128-bit AES
Robustness	FHSS
Latency (from not connected state to send data)	<6ms
Range	Open space: up to 15m Industrial environment: 1-5m
Autonomy	Up to 5 months e.g.: 200,000 transmissions @8h/day, 20d/month, 2,000 data/day

6. Inputting tolerance limits

To input or modify the tolerance limits, t_{ol} → 0_n mode should be selected, followed by a short press on **MODE** :

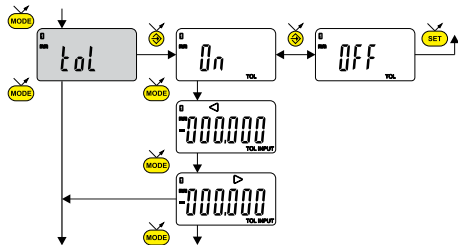

..... Input the lower tolerance limit ◀

..... Input the upper tolerance limit ▶

◀ next digit

SET 0...9

▶ save PRESET



Note :

- For measuring internal dimensions, the red and yellow indicators can be switched over by reversing the order in which the tolerance limits are input (lower limit > upper limit).
- It is possible to input different tolerances on REF1 and REF2.

7. Favourite key

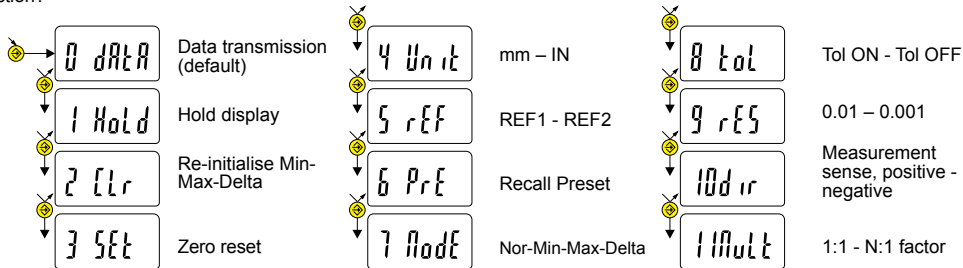
The «favourite» key gives direct access to a predefined function, and can be configured according to the needs of the user. In order to assign a function to the «favourite» key, give a prolonged press on , and then select the required function:



Validation of selection: By a prolonged press on , or a short press on  or 

Note: a function can also be assigned via RS232 using the command <FCT + Function No.>
example: Change of Unit = <FCT4>

8. Switching off

The dial gauge goes automatically into stand-by if not used for 20 minutes, unless Auto OFF mode has been turned off (see Chap. 4, advanced functions)

Stand-by mode can be forced by a prolonged press (> 2 sec) on  :

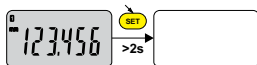

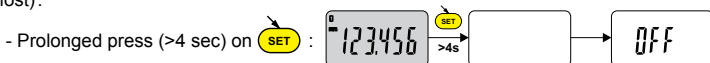

In stand-by mode, the value of the origin is retained by the sensor (SIS mode), and the instrument automatically restarts with any movement of the measurement probe, RS command or press a button.

The instrument can be switched off completely for a long period of non-use, but this will necessitate a zero reset on restart (the origin will be lost):



9. Re-initialising the instrument

The initial instrument settings can be restored at any time by a prolonged press (>4 sec) simultaneously on  and  until the message `rESt` is displayed.

Nevertheless the instrument retains its configuration settings (units and resolution), *Bluetooth*[®] pairing as well as the last active reference.

10. Personalising the instrument

Access to the functions of your instrument can be personalised, for more information see manufacturer's website (requires you to connect your instrument via Proximity or Power RS / USB cable, or *Bluetooth*®).

Possibilities:

- De-activate or active the required functions
- Modify access to the advanced functions (direct access)

11. Connecting the instrument

The instrument can be connected to a peripheral via a Proximity (RS or USB), Power (RS or USB) cable or *Bluetooth*® smart. See page 2 for connecting the Power cable.

Measured values can be transmitted and the instrument driven using predefined commands (see chap. 12 for a list of the main retro-commands)

Note:

In Tolerance mode, the tolerance limit lights remain lit only for a few seconds while the measurement stabilises. On the other hand, they will remain lit continuously if the instrument is connected to, and powered by, the Power RS (USB) cable.

12. List of the main commands

Selection and configuration

CHA+ / CHA-	Change measurement direction
FCT0 ...9...A...F	Assign «favourite» function
MM / IN	Change measurement unit
KEY0 / KEY1	Lock / unlock keypad
MUL [+/-]xxx.xxxx	Modify multiplication factor
PRE [+/-]xxx.xxx	Modify preset value
REF1 / REF2	Change active reference
STO1 / STO0	Activate / de-activate HOLD
TOL1 / TOL0	Activate / de-activate tolerances
LCAL dd.mm.yy	Modify last calibration date
NCAL dd.mm.yy	Modify next calibration date
TOL +/-xxx.xxx +/-yyy.yyy +/-zzz.zzz	Inputting nominal and current tolerance limits
MIN /MAX /DEL /NOR	Selecting MIN, MAX, Delta, Normal mode
CLE	Re-initialisation of MIN, MAX or Delta
UNI1 / UNIO	Activate / de-activate change of units
OUT1 /OUT0	Activate / de-activate contin. data transmission
PRE ON / PRE OFF	Activate / de-activate Preset function
PRE	Recall Preset
SET	Zero reset
RES2 / RES3	Change of resolution
BT0/BT1	Activate / de-activate Bluetooth® module
BTRST	Reset pairing information

Interrogation

CHA?	Measurement sense?
FCT?	«favourite» function active?
UNI?	Measurement unit active?
KEY?	Keypad locked?
MUL?	Multiplication factor?
PRE?	Preset value?
REF?	Reference active?
STO?	Status of HOLD function?
TOL?	Current tolerance limit values?
LCAL?	Date of last calibration?
NCAL?	Date of next calibration?
?	Current value (mode Tol, value followed by <=>)
MOD?	Active mode (MIN, MAX, Delta or Normal)?
SET?	Main instrument parameters?
ID?	Instrument identification code?
Maintenance functions	
BAT?	Battery status (BAT1 = OK, BAT0 = low battery)
OFF	Switch-off (wake up using a button or RS)
RST	Re-initialisation of the instrument
SBY	Put instrument in stand-by (SIS)
VER?	Version No. and date of firmware
MAC?	Bluetooth® MAC address ?

13. Specifications

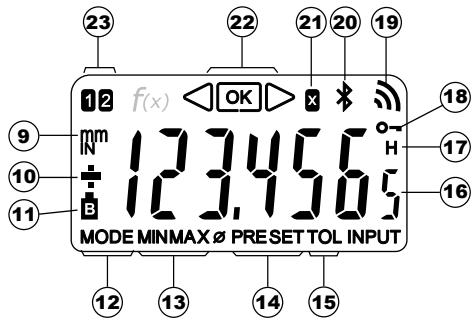
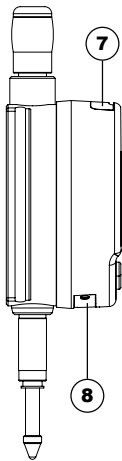
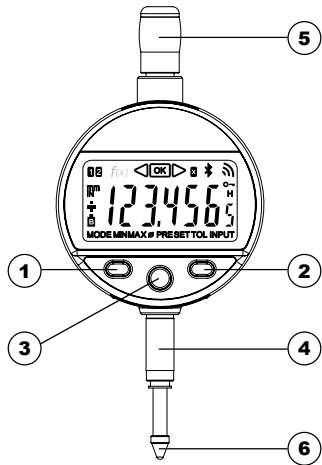

Measurement range:	12.5mm	25mm	50mm	100mm	150mm	
Max error (0.01mm scale):	10 μ m	10 μ m	20 μ m	20 μ m	20 μ m	(\pm 1 digit)
Max error (0.001mm scale):	3 μ m	4 μ m	5 μ m	6 μ m	10 μ m	
Max error (0.0001mm scale):	1.8 μ m	2.2 μ m	---	---	---	
Repeatability:	2 μ m 0.5 μ m (model 0.0001mm scale)					
Weight:	119g	123g	161g	208g	265g	
Measurement force (standard):	0.65-0.9N	0.65-1.15N	1.25-2.7N	1.6-3.5N	2.2-5.7N	
Max. speed of travel:	1.7m/s					
No. of measurements/ sec:	measurement: 10 meas/s MIN/MAX mode: 20 meas/s					
Measurement unit:	metric/english (Inch)					
Maximum Preset (0.01mm scale):	\pm 9999.99 mm / \pm 399.9995 IN					
Maximum Preset (0.001mm scale):	\pm 999.999 mm / \pm 39.99995 IN					
Maximum Preset (0.0001mm scale):	\pm 99.9999 mm / \pm 3.999995 IN					
Measurement system:	Sylvac inductive system (patented)					
Power:	1 x 3V lithium battery, type CR2032, 220mAh					
Average consumption:	73 μ A					
Average battery life:	8'000 hours / <i>Bluetooth</i> ® 3'650 hours					
Data output:	RS232 compatible					
Range:	up to 15m (depending on the environment)					
Working temperature (storage):	+5 to +40°C (-10 to +60°C)					
Electromagnetic compatibility:	as per EN 61326-1					
IP rating (in accordance with IEC60529):	IP 51 / IP 67 (depending on model)					
Fixing and space envelope:	Ø8h6 (3/8"), interchangeable M2.5 (4-48-UNF) probe (as per DIN 878)					

F

Description

1. Bouton MODE
2. Bouton SET
3. Bouton "Favoris"
4. Canon de fixation Ø8 ou 3/8"
5. Bonnette de relevage
6. Touche à bille Ø2/M2.5 ou 4-48-UNF
7. Logement pour câble Proximity
8. Logement batterie ou câble Power
9. Unité de mesure (mm/INCH)
10. Indicateur +/-
11. Batterie faible
12. Indication du menu MODE
13. Mode MIN/MAX/DELTA
14. Mode Preset
15. Mode tolérance actif
16. Affichage 6 digits
17. Gel de la valeur de mesure
18. Verrouillage des boutons
19. Envoi de données
20. Connexion *Bluetooth*® (dépendant de la version)
21. Facteur de multiplication
22. Indicateur des tolérances
23. Indicateur de la référence active

1. Les fonctionnalités de l'instrument

-  L'instrument possède 2 modes de travail : fonctions de base (avec accès direct) et fonctions avancées. En plus des fonctions de configuration, vous pouvez accéder à 2 référence de travail, au mode MIN, MAX et DELTA (TIR), à l'affichage des tolérances, ou à l'introduction d'un facteur de multiplication (voir chap. 3 et 4)
-  Le bouton « favori » permet d'attribuer un accès direct à la fonction principalement utilisée (voir chap. 7)
-  Le bouton « SET » permet d'attribuer une valeur de Preset, de réinitialiser le mode MIN/MAX, de quitter une sélection, et de gérer l'extinction de l'instrument. Par défaut, le mode SIS permet l'extinction automatique sans perte de l'origine (voir chap. 8).

- Personnalisation des fonctions

Vous avez la possibilité d'activer ou désactiver certaines fonctions de l'instrument par RS232 (voir chap. 10)

- Paramètres de transmission de données

4800Bds, 7 bits, parité paire, 2 stop bits

2. Démarrer

Presser un bouton. Lors de la première utilisation, l'instrument demande de sélectionner l'unité de mesure désirée (mV ou V). Choisissez..... puis mesurez.
Pour une connexion *Bluetooth*® voir chapitre 5.

3. Fonctions de base

Chaque pression courte sur  permet un accès direct aux fonctions de base :

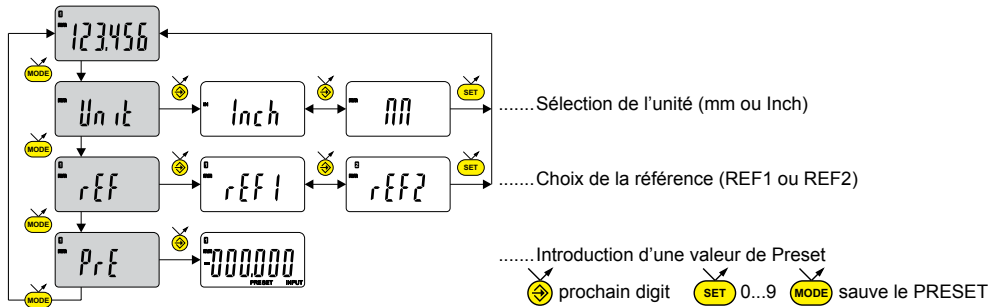

Remarque : Il est possible d'attribuer une valeur de preset différente à chacune des 2 Références. De même, on peut attribuer des limites de tolérances différentes sur les références 1 et 2.

4. Fonctions avancées

Une pression longue (>2s) sur **MODE** permet d'accéder aux fonctions avancées. Puis, chaque pression courte sur **MODE** accède à la fonction souhaitée :

F

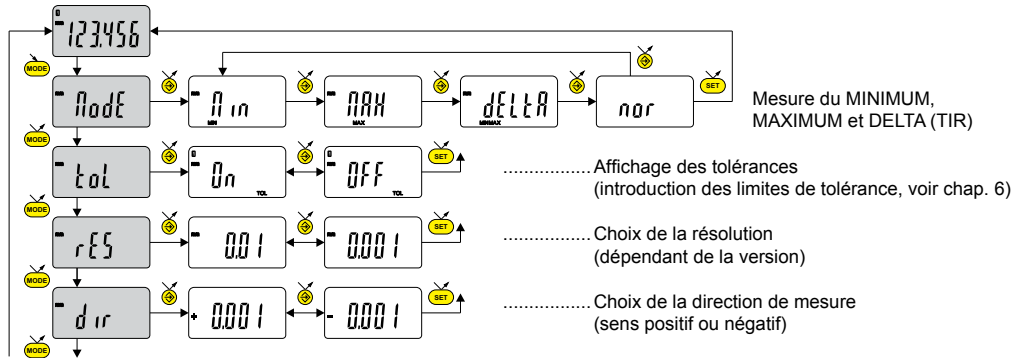

..... suite

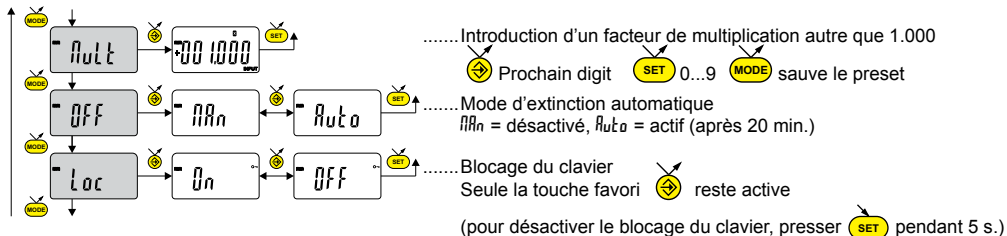

Remarque :

Il est également possible d'afficher les limites de tolérance lorsque l'instrument travaille en mode MIN, MAX ou DELTA (TIR)

- Si aucune limite de tolérance n'a été définie par l'utilisateur, l'instrument affichera les indicateurs de limites de tolérances ◀ [OK] ▶ , mais sans activer les indicateurs lumineux (rouge – vert - jaune)

..... suite

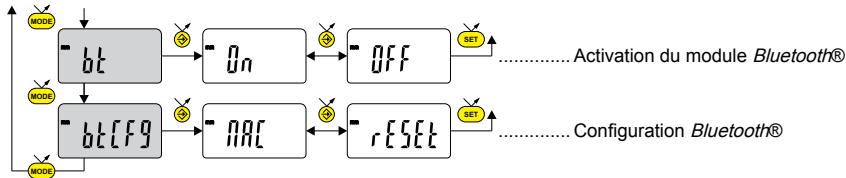

F

5. Configuration *Bluetooth*®

La procédure de connexion a été pensée au plus simple et se distingue par les 3 états ci-dessous :

- 1° Symbole ✖ éteint..... mode déconnecté
- 2° Symbole ✖ clignote mode découverte
- 3° Symbole ✖ allumé mode connecté

Connexion :

- 1° S'assurer que l'application et le matériel *Bluetooth*® Smart compatibles sont actifs (PC, unité de mesure).
- 2° Démarrer l'instrument. Par défaut le module *Bluetooth*® est actif et l'instrument est connectable durant 120s (mode découverte).

3° Dès que l'instrument est détecté la connexion est automatique. Si la connexion n'a pas été établie durant les 120s, réactiver le module *Bluetooth*® via le menu *bt / On*

4° L'instrument est prêt à transmettre (mode connecté)

Appairage :

L'appairage de l'instrument avec le maître se fait automatiquement à la première connexion.

Pour connecter un instrument à un nouveau maître (nouvel appairage) il est nécessaire d'effacer ses informations d'appairage via le menu *bt [F9] / rESEt*.



5.1 Spécification *Bluetooth*®

Fréquence radio	2.4Ghz
Sécurité	128-bit AES
Robustesse	FHSS
Latence (connexion + envoi de donnée)	<6ms
Portée	Espace ouvert : jusqu'à 15m Environnement industriel : 1-5m
Autonomie	Jusqu'à 5 mois Ex: 200'000 transmissions @8h/jour, 20j/mois, 2'000 data/jour

6. Introduction des limites de tolérances

Pour introduire ou modifier les limites de tolérances, il faut sélectionner le mode t_{ol} → U_n , suivi d'une pression courte sur **MODE**

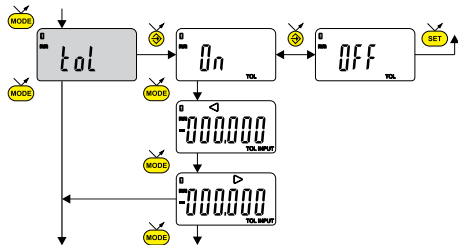

..... Introduire la limite de tolérance inférieure ◀

..... Introduire la limite de tolérance supérieure ▶

◀ prochain digit SET 0...9 MODE sauve le PRESET

Remarque :



- Dans le cas de mesure de cotes d'intérieur, on peut croiser les indicateurs (rouge et jaune) en inversant l'ordre d'introduction des limites de tolérances (limite inférieure > limite supérieure).
- Il est possible d'introduire des limites de tolérances différentes sur les REF1 et REF2.

7. Touche favori

La touche « favori » permet l'accès direct à une fonction prédéfinie et peut être configurée selon les besoins de l'utilisateur.

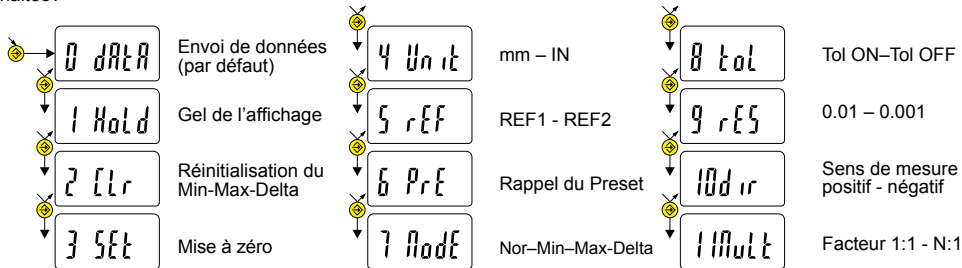
Pour attribuer une fonction à la touche « favori », effectuer une pression longue (>2s) sur , puis sélectionner la fonction souhaitée :





Validation de la sélection : Par une pression longue sur , ou une pression courte sur  ou 

Remarque : l'attribution de la fonction peut également se faire par RS 232, avec la commande <FCT + N° de fonction>
exemple : Changement d'unité = <FCT4>

8. Extinction

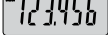
Le comparateur se met automatiquement en stand-by après 20 minutes de non utilisation, sauf si le mode Auto OFF est désactivé (voir chap.4 fonctions avancées)

Vous pouvez forcer le mode stand-by, par pression longue (>2s) sur  :    >2s



En mode stand-by, la valeur d'origine est conservée par le capteur (mode SIS), et l'instrument redémarre automatiquement par un mouvement de la touche de mesure ainsi que par commande RS, ou par pression sur un bouton.

Il est possible d'éteindre complètement l'instrument pour une longue période de non utilisation, mais cela nécessitera une remise à zéro à l'enclenchement (perte de l'origine):

- Effectuer une pression longue (>4s) sur  :    →  >4s

9. Réinitialisation de l'instrument

A tout moment, il est possible de restaurer les réglages initiaux de l'instrument, par une pression longue (>4s) simultanée

sur  et  jusqu'à l'affichage du message *rESt*.

L'instrument conserve néanmoins les réglages de configuration (unité et résolution), d'appairage ainsi que la dernière référence active.

10. Personnalisation de l'instrument

Il est possible de personnaliser l'accès aux fonctions de votre instrument, pour plus d'information voir site-web du fabricant (nécessite une connexion de votre instrument, via un câble Proximity ou Power RS / USB, ou *Bluetooth*®).

Possibilités :

- Désactiver ou activer les fonctions souhaitées
- Modifier l'accès aux fonctions avancées (mise en accès direct)

F

11. Connexion de l'instrument

L'instrument peut être connecté à un périphérique, via un câble Proximity (RS ou USB), ou Power-RS (Power-USB) ou *Bluetooth*® smart. Voir en page 2 pour la connexion des câbles.

Possibilité de transmettre les valeurs mesurées, et piloter l'instrument à l'aide de rétro-commandes prédéfinies (liste des commandes principales, voir chap.12)

Remarque :

En mode Tolérance, les indicateurs lumineux des limites de tolérances ne restent allumés que quelques secondes lorsque la mesure est stabilisée. Par contre, ils resteront allumés en permanence si l'instrument est connecté et alimenté par le Power RS (USB).

12. Liste des commandes principales

Sélection et configuration

CHA+ / CHA-	Changement direction de mesure
FCT0 ...9...A...F	Attribution fonction «favori»
MM / IN	Changement unité de mesure
KEY0 / KEY1	Active / désactive le blocage clavier
MUL [+/-]xxx.xxxx	Modification facteur de multiplication
PRE [+/-]xxx.xxx	Modification valeur de preset
REF1 / REF2	Changement de la référence active
STO1 / STO0	Active / désactive le HOLD
TOL1 / TOL0	Active / désactive les tolérances
LCAL dd.mm.yy	Modifie date dernière calibration
NCAL dd.mm.yy	Modifie date prochaine calibration
TOL +/-xxx.xxx +/-yyy.yyy +/-zzz.zzz	Introduction nominale et limites de tolérances actuelles
MIN / MAX / DEL / NOR	Sélection mode MIN, MAX, Delta, Normal
CLE	Réinitialisation du MIN, MAX ou Delta
UNI1 / UNIO	Active / désactive le changement d'unité
OUT0	Active / désact. transmission données en continu
PRE ON / PRE OFF	Active / désact. la fonction Preset
PRE	Rappel du Preset
SET	Mise à zéro
RES2 / RES3	Changement résolution
BT0/BT1	Active / désactive le mode Bluetooth®
BTRST	Réinitialisation de l'appairage

Interrogation

CHA?	Sens de mesure?
FCT?	Fonction «favori» active?
UNI?	Unité de mesure active?
KEY?	Blocage clavier?
MUL?	Facteur de multiplication?
PRE?	Valeur de preset?
REF?	Référence active?
STO?	Etat fonction HOLD?
TOL?	Valeur des limites de tol actuelles?
LCAL?	Date dernière calibration?
NCAL?	Date prochaine calibration?
?	Valeur actuelle? (mode Tol, valeur suivie de <=>)
MOD?	Mode actif (MIN, MAX, Delta ou Normal)?
SET?	Paramètres principaux de l'instrument?
ID?	Code d'identification de l'instrument?OUT1 /
Fonctions de maintenance	
BAT?	Etat pile (BAT1=Ok, BAT0=pile faible)
OFF	Extinct. complète (réveil par bouton ou RS)
RST	Réinitialisation de l'instrument
SBY	Mise en Stand by de l'instrument (SIS)
VER?	Révision et date du firmware
MAC?	Adresse MAC du module Bluetooth®

13. Spécifications

Etendue de mesure:	12.5mm	25mm	
Erreur max (résolution 0.01mm):	10µm	10µm	(±1 digit)
Erreur max (résolution 0.001mm):	3µm	4µm	
Répétabilité:		2µm	
Poids:	119g	123g	
Force de mesure (standard):	0.65-0.9N	0.65-1.15N	
Vitesse max. de déplacement:	1.7m/s		
Nbre de mesure par seconde:	mesure: 10 mes/s mode MIN/MAX: 20 mes/s		
Unité de mesure:	métrique/anglaise (Inch)		
Preset maximum (résolution 0.01mm):	±9999.99 mm / ±399.9995 IN		
Preset maximum (résolution 0.001mm):	±999.999 mm / ±39.99995 IN		
Valeur échelon échelle analogique	min 0.2 µm - max 1 mm / min 0.01 thou - 0.05 IN		
Capacité échelle analogique	min ±5 µm - max ±25 mm / min ± 0.25 thou - max ± 1.25 IN		
Système de mesure:	Sylvac inductive system (breveté)		
Alimentation:	1 batterie lithium 3V, type CR2032, capacité 220mAh		
Consommation moyenne:	75µA		
Autonomie moyenne:	8'000 heures		
Sortie de données:	compatible RS232		
Portée:	jusqu'à 15m (dépend de l'environnement)		
Température de travail (stockage):	+5 à +40°C (-10 à +60°C)		
Compatibilité électromagnétique:	selon EN 61326-1		
Spécification IP (selon IEC60529):	IP 51		
Fixation et encombrement:	fixation Ø8h6 (3/8"), touche de mesure interchangeable M2.5 (4-48-UNF) (selon DIN 878)		

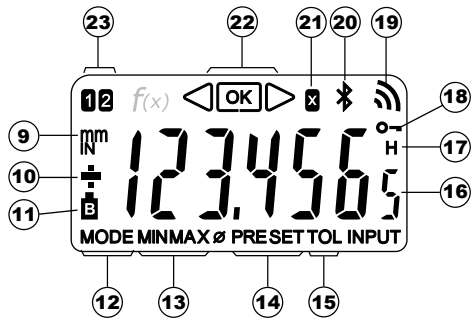
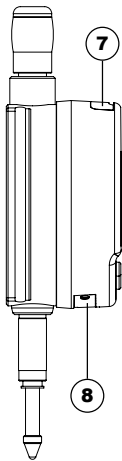
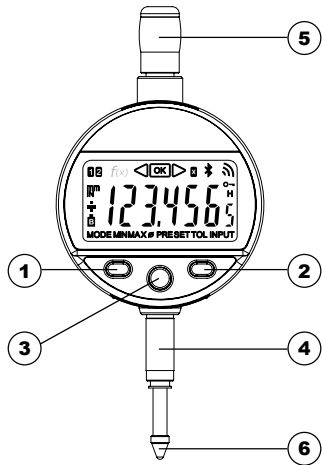

F

D

Beschreibung

1. MODE-Taste
2. SET-Taste
3. Favoriten-Taste
4. Einspannschaft Ø8 oder 3/8"
5. Abhebekapsel
6. Kugeltaster Ø2/M2.5 oder 4-48-UNF
7. Buchse für Proximity Kabel
8. Batterieeinschub oder Netzkabelbuchse
9. Masseinheit (mm/INCH)
10. +/- Anzeige
11. Batterie schwach
12. Anzeige des Menüs Mode
13. MIN/MAX/DELTA-Modus
14. Preset-Modus
15. Toleranz-Modus
16. Anzeige von 6 Ziffern
17. Festhalten des Messwerts
18. Tastatursperre
19. Datenübertragung
20. *Bluetooth*®-Verbindung (versionsabhängig)
21. Multiplikationsfaktor
22. Toleranzanzeiger
23. Aktive Referenz

1. Funktionalitäten des Instruments:

-  Das Instrument verfügt über zwei Betriebsarten: Basisfunktionen (mit direktem Zugang) und fortgeschrittene Funktionen. Neben den Konfigurationsfunktionen hat man Zugriff auf 2 Arbeitsreferenzen, den Modi MIN, MAX und DELTA (TIR), auf die Toleranzanzeige oder auf die Eingabe eines anderen Multiplikationsfaktors als 1:1. (siehe Kap. 3 und 4).
 -  Mit der Taste „Favoriten“ kann man der hauptsächlich verwendeten Funktion einen direkten Zugriff zuzuweisen (siehe Kap. 7)
 -  Ermöglicht die Zuweisung eines Presetwertes, die Reinitialisierung der Modi MIN/MAX, die Quittierung einer Auswahl und die Steuerung des Ausschaltens des Instruments. Der SIS-Modus ermöglicht standardmässig das automatische Ausschalten ohne Verlust der Anfangseinstellung (siehe Kap. 8).
- **Personalisierung der Funktionen**
Es ist möglich, einige Funktionen des Instruments über R232 zu aktivieren oder zu deaktivieren (siehe Kap.10)
- **Parameter für Datenübertragung**
4800Bds, 7 Bits, gerade Parität, 2 Stoppbits

2. Starten

Eine Taste drücken. Beim Erstgebrauch verlangt das Instrument, die gewünschte Masseinheit zu wählen (m oder l_n). Wählen Sie... und messen Sie.
Zur *Bluetooth*®-Verbindung siehe Kapitel 5.

3. Grundfunktionen

Jede kurze Betätigung von  ermöglicht einen direkten Zugriff auf die Grundfunktionen:

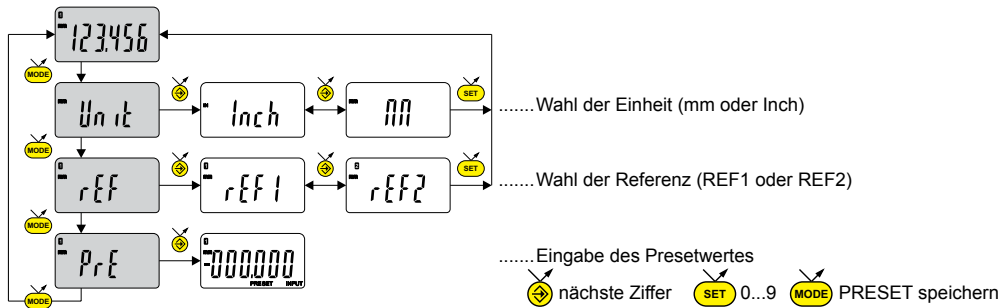

Anmerkung: Es ist möglich, jeder der beiden Referenzen einen unterschiedlichen Presetwert zuzuordnen. Ebenso kann man den Referenzen 1 und 2 unterschiedliche Toleranzgrenzen zuordnen.

4. Fortgeschrittene Funktionen

Eine lange Betätigung (>2s) von **MODE** ermöglicht es, auf die fortgeschrittenen Funktionen zuzugreifen. Anschließend führt jede kurze Betätigung von **MODE** zur gewünschten Funktion:

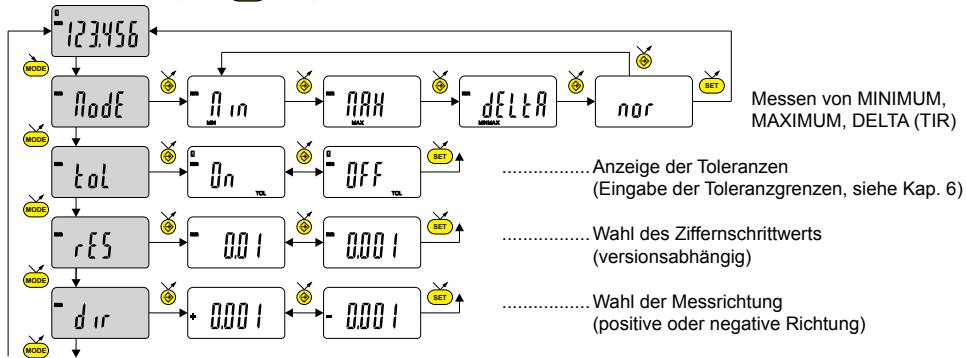

- Anzeige der Toleranzen
(Eingabe der Toleranzgrenzen, siehe Kap. 6)
- Wahl des Ziffernschrittwerts
(versionsabhängig)
- Wahl der Messrichtung
(positive oder negative Richtung)

..... Fortsetzung

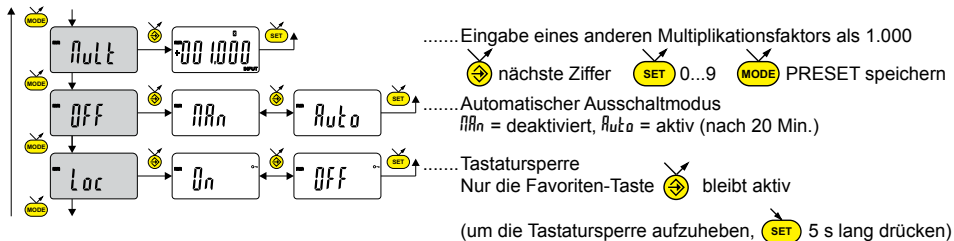

Anmerkung:

Es ist auch möglich, die Toleranzwerte anzuzeigen, wenn das Instrument in der Betriebsart MIN, MAX oder DELTA (TIR) arbeitet.

- Wenn der Nutzer keine Toleranzgrenze festgelegt hat, stellt das Instrument die Toleranzgrenzanzeiger dar ◀ OK ▶ aber ohne die Leuchtmelder (rot – grün – gelb) zu aktivieren.



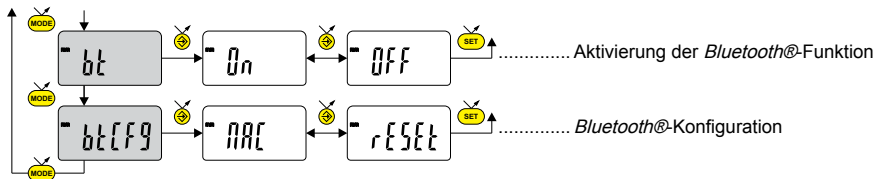

..... Fortsetzung



D

5. Bluetooth®-Konfiguration

Der Verbindungsaufbau ist ganz einfach und wird in 3 Zuständen angezeigt:

- 1° Kein  Symbol keine Verbindung
- 2° Blinkendes  Symbolbereit zur Verbindung
- 3° Stehendes  SymbolVerbindung hergestellt

Verbindungsaufbau:

- 1° Stellen Sie sicher, dass die *Bluetooth®* Smart Anwendung und das Gerät kompatibel und aktiv sind (PC, Messeinheit).
- 2° Schalten Sie das Instrument ein. Die *Bluetooth®*-Funktion ist standardmäßig aktiviert und das Instrument kann innerhalb von 120 s verbunden werden (Verbindung wird gesucht).

- 3° Sobald das Instrument gefunden wurde, wird die Verbindung automatisch hergestellt. Wurde innerhalb von 120 s keine Verbindung hergestellt, aktivieren Sie *Bluetooth®* erneut über das Menü *bt / Ün*.
- 4° Das Gerät ist bereit zum Senden (Verbindung hergestellt)

Kopplung:

Die Kopplung des Instruments an dem Master erfolgt automatisch bei der ersten Verbindung.

Um das Instrument mit einem neuen Master zu verbinden (Neue Kopplung), müssen diese Einstellungen über das Menü *bt [F9] / rEStt* gelöscht werden.

5.1 Technische Daten der *Bluetooth®*-Funktion



Frequenz	2,4 Ghz
Sicherheit	128-bit AES
Robustheit	FHSS
Latenz (Verbindung + Daten senden)	<6ms
Reichweite	Im Freien: bis 15 m Industrienumgebung: 1-5 m
Autonomie	Bis 5 Monate z. B.: 200.000 Übertragungen bei 8 Std./Tag, 20 Tage/Monat, 2.000 Daten/Tag

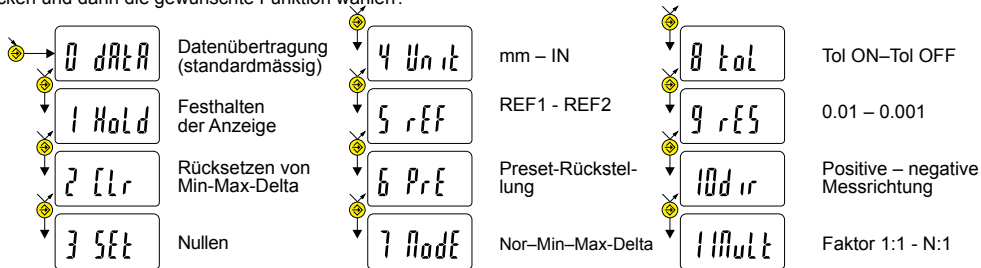

7. Favoriten-Taste

Die „Favoriten-Taste“ ermöglicht den direkten Zugriff auf eine zuvor bestimmte Funktion und kann entsprechend der Bedürfnisse des Nutzers konfiguriert werden. Um der „Favoriten-Taste“ eine Funktion zuzuordnen, muss man lange auf  drücken und dann die gewünschte Funktion wählen:



Bestätigung der Auswahl: Durch langes Drücken von  oder kurzes Drücken von  oder 

Anmerkung: Die Zuordnung der Funktion kann auch durch RS 232 erfolgen, mit der Steuerung <FCT + Funktions-Nr.>
Beispiel: Masseinheit = <FCT4>

8. Ausschalten

Die Messuhr stellt sich nach 20 Minuten Nichtgebrauch automatisch auf Stand-By, außer wenn die Betriebsart Auto OFF deaktiviert ist (siehe Kap. 4, fortgeschrittene Funktionen).

Stand-By-Funktion durch langes Betätigen (>2s) von  erzwingen.

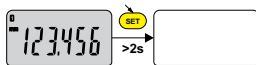

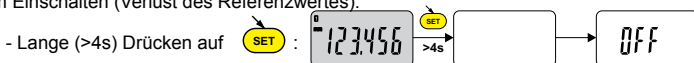

Im Stand-By-Modus wird der Referenzwert vom Sensor (SIS Modus) beibehalten und das Instrument startet automatisch mit einer Bewegung des Messeinsatzes sowie über RS, oder eine Taste drücken.

Es ist möglich, das Instrument für eine lange Zeit des Nichtgebrauchs vollständig auszuschalten, aber das erfordert eine Rückstellung beim Einschalten (Verlust des Referenzwertes).



9. Rücksetzen des Instruments

Man kann die Werkseinstellungen des Instruments jederzeit mit einem langen (>4s), gleichzeitigen Drücken bis zur Anzeige der Meldung  auf  und  wiederherstellen.

Das Instrument behält jedoch die Konfigurationseinstellungen (Einheit und Auflösung), die Anpassung sowie die letzte aktive Referenz.

10. Personalisierung des Instruments

Es ist möglich, den Zugriff auf die Funktionen Ihres Instruments mit Hilfe der kostenlosen Software zu personalisieren. Weitere Informationen finden Sie auf der Webseite des Herstellers (erfordert den Anschluss Ihres Instruments mit einem Proximity-Kabel oder RS / USB Power, oder *Bluetooth*®).

Möglichkeiten:

- die Deaktivierung oder Aktivierung der erwünschten Funktionen
- die Änderung des Zugriffs auf die fortgeschrittenen Funktionen (Schaffung eines direkten Zugriffs)

11. Anschluss des Instruments

Das Instrument kann mit einem Proximity-Kabel (RS oder USB) oder Power-RS (Power-USB) oder über eine *Bluetooth*® Smart-Verbindung an ein Peripheriegerät angeschlossen werden. Informationen zum Kabelanschluss finden Sie auf Seite 2

Man kann die gemessenen Werte übertragen und das Instrument mit Hilfe von bestimmten Befehlen steuern. Liste der wesentlichen Steuerbefehle, siehe Kap. 12.

Anmerkung:

Im Toleranzmodus leuchten die Leuchtanzeigen der Toleranzgrenzen nur einige Sekunden, wenn die Messung stabilisiert ist. Sie bleiben jedoch ständig an, falls das Instrument durch das Power-RS- (USB-) Kabel angeschlossen ist und gespeist wird.

12. Liste der wesentlichen Steuerbefehle

Auswahl un Konfiguration

CHA+ / CHA-	Wechsel der Messrichtung
FCT0 ...9...A...F	Zuordnung der Funktion „Favorit“
MM / IN	Wechsel der Masseinheit
KEY0 / KEY1	Aktiviert / Deaktiviert die Tastatursperre
MUL [+/-]xxx.xxxx	Änderung des Multiplikationsfaktors
PRE [+/-]xxx.xxx	Änderung des Presetwertes
REF1 / REF2	Wechsel der aktiven Referenz
STO1 / STO0	Aktiviert / Deaktiviert den HOLD
TOL1 / TOL0	Aktiviert / Deaktiviert die Toleranzen
LCAL dd.mm.yy	Ändert das Datum der letzten Kalibrierung
NCAL dd.mm.yy	Ändert das Datum der nächsten Kalibrierung
TOL +/-xxx.xxx +/-yyy.yyy +/-zzz.zzz	Eingabe Nominalwert und Toleranzen
MIN / MAX / DEL / NOR	Auswahl des Modus MIN, MAX, Delta, Normal
CLE	Rücksetzen von Min, Max oder Delta
UNI1 / UNIO	Aktiviert / Deaktiviert den Einheitswechsel
OUT1 /OUT0	Aktiviert / Deaktiviert die kontinuierliche Datenübertragung
PRE ON / PRE OFF	Aktiviert /Deaktiviert die Presetfunktion
PRE	Preset-Rückstellung
SET	Nullen
RES2 / RES3	Ändern des Ziffernschrittwerts
BT0/BT1	Aktiviert / deaktiviert die Bluetooth®-Funktionw
BTRST	Löschen der Bluetooth® Kopplung

Abfragen

CHA?	Messrichtung?
FCT?	Funktion „Favorit“ aktiv?
UNI?	Masseinheit aktiv
KEY?	Tastatursperre?
MUL?	Multiplikationsfaktor?
PRE?	Presetwert?
REF?	Aktive Referenz?
STO?	HOLD Funktionsstatus?
TOL?	Wert der aktuellen Tol.-Grenzen?
LCAL?	Datum der letzten Kalibrierung?
NCAL?	Datum der nächsten Kalibrierung?
?	Aktueller Wert (Tol.-Modus, Wert gefolgt von <=>)
MOD?	Aktiver Modus (MIN, MAX, Delta oder Normal)?
SET?	Hauptparameter des Instruments?
ID?	Identifizierungscode des Instruments?

Wartungsfunktionen

BAT?	Batteriestatus (BAT1=Ok, BAT0=Batterie schwach)
OFF	Vollständ. Ausschalten (Neuaktivierung mit Knopf oder RS)
RST	Rücksetzen des Instruments
SBY	Setzen des Instruments auf Stand-By (SIS)
VER?	Revision und Datum der Firmware
MAC?	MAC-Adresse des Bluetooth®-Moduls

13. Spezifizierungen

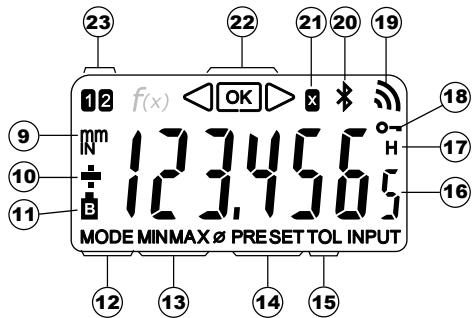
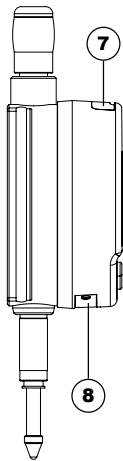
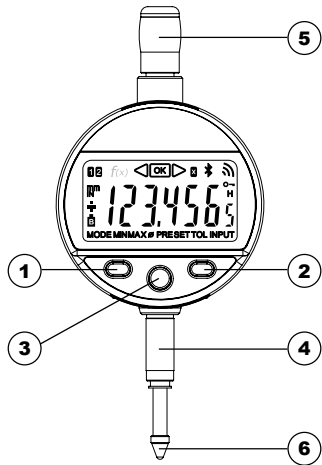

Messbereich:	12.5mm	25mm	50mm	100mm	150mm	
Fehlergrenze (Stufe 0.01mm):	10µm	10µm	20µm	20µm	20µm	(±1 digit)
Fehlergrenze (Stufe 0.001mm):	3µm	4µm	5µm	6µm	10µm	
Fehlergrenze (Stufe 0.0001mm):	1.8µm	2.2µm	---	---	---	
Wiederholbarkeit:	2µm 0.5µm (Stufe 0.0001mm)					
Gewicht:	119g	123g	161g	208g	265g	
Messkraft (Standard):	0.65-0.9N	0.65-1.15N	1.25-2.7N	1.6-3.5N	2.2-5.7N	
Maximale Bewegungsgeschwindigkeit:	1.7m/s					
Anzahl der Messungen pro Sekunde:	Messung: 10 Mess/s			Betriebsart MIN/MAX: 20 Mess/s		
Masseinheit:	mm / Inch					
Maximum Preset (Stufe 0.01mm):	±9999.99 mm / ±399.9995 IN					
Maximum Preset (Stufe 0.001mm):	±999.999 mm / ±39.99995 IN					
Maximum Preset (Stufe 0.0001mm):	±99.9999 mm / ±3.999995 IN					
Messsystem:	Sylvac inductive system (patentiert)					
Versorgung:	1 x 3 V Lithiumbatterie, Typ CR2032, Kapazität 220 mAh					
Durchschnittlicher Verbrauch:	73µA					
Durchschnittliche Autonomie:	8.000 Stunden / Bluetooth® bis 3.650 Stunden					
Datenausgang:	RS232 kompatibel					
Reichweite	bis 15 m (umgebungsabhängig)					
Arbeitstemperatur (Lagerung):	+5 bis +40°C (-10 bis +60°C)					
Elektromagnetische Verträglichkeit:	gemäß EN 61326-1					
IP Spezifikation (gemäß IEC60529):	IP 51 / IP 67 (je nach Modell)					
Befestigung und Platzbedarf:	Ø8h6 (3/8") Befestigung, austauschbarer M2.5 (4-48-UNF) Messeinsatz (gemäß DIN 878)					



Description

1. Pulsante Modalità
2. Pulsante Impostazione
3. Pulsante « Preferiti »
4. Albero di fissaggio Ø8 o 3/8"
5. Elemento di sollevamento
6. Tasto a sfera Ø2/M2.5 o 4-48-UNF
7. Alloggiamento per cavo di Proximity
8. Alloggiamento batteria o cavo di alimentazione
9. Unità di misura (mm/INCH)
10. Indicatori +/-
11. Batteria scarica
12. Indicazione del menu Modalità
13. Modalità MIN/MAX/DELTA
14. Modalità Preset
15. Modalità Tolleranze
16. Visualizzazione a 6 cifre
17. Congelamento del valore di misura
18. Blocco pulsant
19. Invio dati
20. Connessione *Bluetooth*® (a seconda della versione)
21. Fattore di moltiplicazione
22. Indicatori di tolleranze
23. Riferimento attivo

1. Funzionalità dello strumento

-  Lo strumento dispone di 2 modalità operative: funzioni base (con accesso diretto) e funzioni avanzate. Oltre alle funzioni di configurazione, si ha accesso a 2 riferimenti di lavoro, alla modalità MIN, MAX e DELTA (TIR), alla visualizzazione delle tolleranze o all'inserimento di un fattore di moltiplicazione diverso da 1:1. (consultare i capitoli 3 e 4)
-  Il tasto «preferito» permette di attribuire un accesso diretto alla funzione utilizzata maggiormente (consultare il capitolo 7)
-  Permette di attribuire un valore di Preset, di reinizializzare la modalità MIN/MAX, di confermare una selezione e di gestire lo spegnimento dello strumento. Per impostazione predefinita, la modalità SIS permette lo spegnimento automatico senza perdita dell'origine (consultare il capitolo 8)

- Personalizzazione delle funzioni

È possibile attivare o disattivare determinate funzioni dello strumento mediante RS232 (consultare il capitolo 10)

- Parametri di trasmissione dati

4800Bds, 7 bit, parità, 2 stop bit

2. Avvio

Premere un pulsante. In occasione del primo utilizzo, lo strumento chiederà di selezionare l'unità di misura desiderata (μm o l_n). Effettuare la selezione..... e procedere alla misurazione.

Per una connessione *Bluetooth*® vedere il capitolo 5.

3. Funzione di base

Ogni breve pressione su  permette l'accesso diretto alle funzioni base:

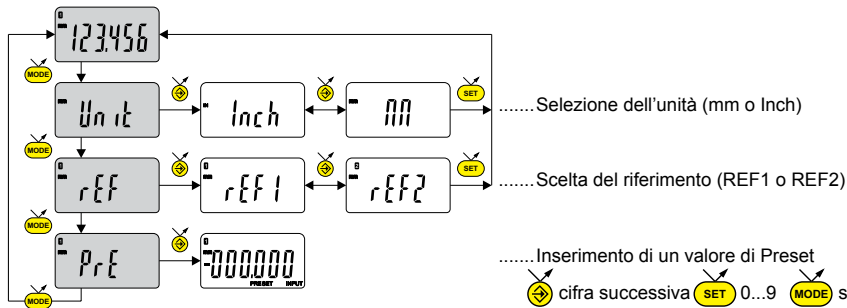

Nota: è possibile assegnare un valore di preset differente a ognuno dei 2 riferimenti. Analogamente è possibile assegnare dei limiti di tolleranza diversi sui riferimenti 1 e 2.

4. Funzioni avanzate

Una pressione lunga (>2s) su **MODE** permette di accedere alle funzioni avanzate. Successivamente, ogni breve pressione su **MODE** accede alla funzione desiderata:

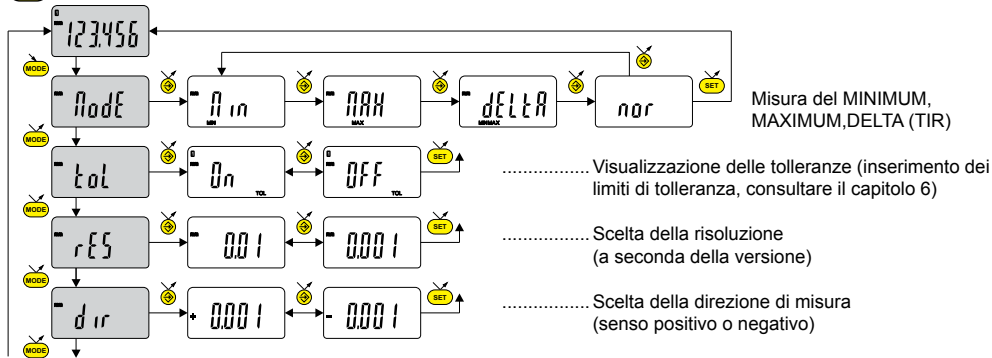

..... segue

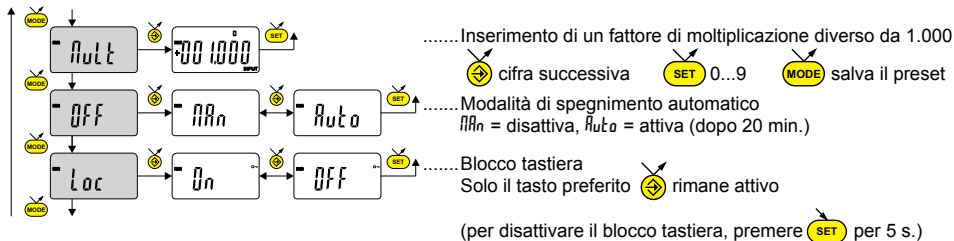

Nota:

È anche possibile visualizzare i limiti di tolleranza mentre lo strumento è in modalità MIN, MAX o DELTA (TIR)

- Se l'utente non ha definito nessun limite di tolleranza, lo strumento visualizza gli indicatori dei limiti di tolleranze ◀ [OK] ▶
ma senza attivare le spie (rosso - verde - giallo)

..... segue

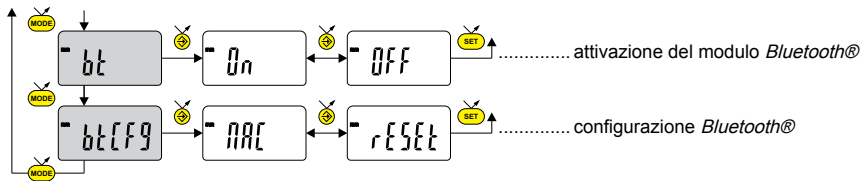

5. Configurazione *Bluetooth*®

La procedura di connessione è stata pensata per essere semplice e distingue i seguenti 3 stati:

- 1° Simbolo ✖ spentomodalità scollegata
- 2° Simbolo ✖ lampeggiantemodalità scoperta
- 3° Simbolo ✖ accesomodalità collegata

Connessione:

- 1° Assicurarsi che l'applicazione e il materiale *Bluetooth*® Smart compatibili siano attivi (PC, unità di misura).
- 2° Avviare lo strumento. Come impostazione predefinita il modulo *Bluetooth*® è attivo e lo strumento è collegabile in 120 s (modalità scoperta).

3° Da quando lo strumento è rilevato il collegamento è automatico. Se il collegamento non è stato stabilito in 120 s, riattivare il modulo *Bluetooth®* mediante il menu *bt / On*

4° Lo strumento è pronto alla trasmissione (modalità collegata)

Accoppiamento :

L'accoppiamento dello strumento con la matrice avviene automaticamente al primo collegamento.

Per collegare uno strumento a una nuova matrice (nuovo accoppiamento) è necessario cancellare le informazioni di accoppiamento mediante il menu *bt [F9] / rEStt*.

5.1 Specifiche *Bluetooth®*

Radiofrequenza	2,4Ghz
Sicurezza	128-bit AES
Resistenza	FHSS
Latenza (connessione + invio dati)	<6ms
Portata	Spazio aperto: fi no a 15 m Ambiente industriale: 1-5m
Autonomia	Fino a 5 mesi Per es.: 200.000 trasmissioni @8h/giorno, 20gg/mese, 2.000 data/giorno

6. Inserimento dei limiti di tolleranza

Per inserire o modificare i limiti di tolleranza, occorre selezionare la modalità $t_{ol} \rightarrow U_n$, seguita da una breve pressione

su **MODE**:

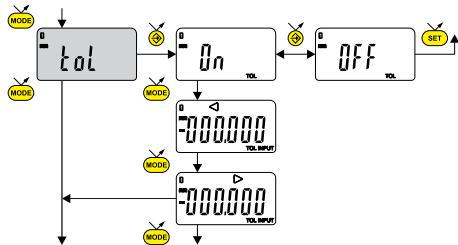

..... Inserire il limite di tolleranza inferiore ◀

..... Inserire il limite di tolleranza superiore ▶

MODE cifra successiva **SET** 0...9 **MODE** salva il PRESET



Nota:

- In caso di misura di dimensioni interne, è possibile incrociare le spie (rossa e gialla) invertendo l'ordine d'inserimento dei limiti di tolleranza (limite inferiore > limite superiore).
- È possibile inserire dei limiti di tolleranza diversi sui REF1 e REF2.

7. Tasto preferito

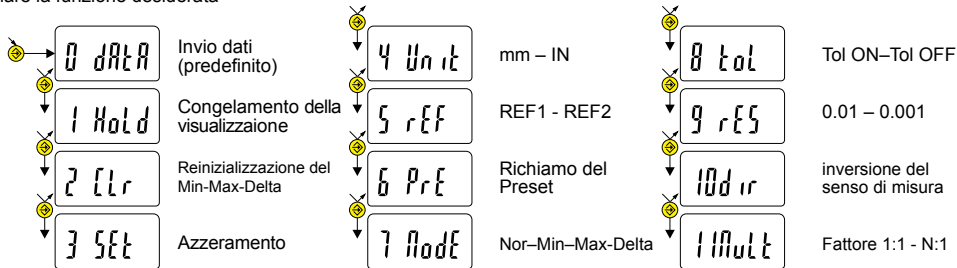
Il tasto «preferito» permette di accedere direttamente a una funzione predefinita e può essere configurato secondo le esigenze dell'utente. Per assegnare una funzione al tasto «preferito», applicare una pressione lunga su , quindi selezionare la funzione desiderata



Conferma della selezione: mediante pressione lunga su , o una breve pressione su  o 

Nota: la funzione può essere assegnata anche mediante RS 232, con il comando <FCT + N° di funzione>
esempio: Modifica di unità di misura = <FCT4>

8. Spegnimento

Il comparatore va automaticamente in stand-by dopo 20 minuti di inattività, tranne se la modalità Auto OFF è disattivata (consultare il capitolo 4 funzioni avanzate)

È possibile forzare la modalità stand-by, con una pressione lunga (>2s) su  :

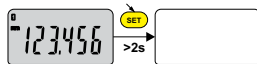



In modalità stand-by, il valore di origine è memorizzato dal sensore (modalità SIS), e lo strumento si riavvia automaticamente con un movimento del tasto di misura mediante il comando RS, o premere un pulsante.

È possibile spegnere completamente lo strumento per un lungo periodo di non utilizzo, ma sarà necessario un azzeramento al momento del collegamento (perdita dell'origine):



9. Reinizializzazione dello strumento

In qualsiasi momento è possibile ripristinare le impostazioni originali dello strumento con una pressione lunga (>4s) contemporanea su  e  fino a visualizzare il messaggio `rESt`.

Lo strumento conserva tuttavia le impostazioni di configurazione (unità e risoluzione) di accoppiamento e l'ultimo riferimento attivo.

10. Personalizzazione dello strumento

È possibile personalizzare l'accesso alle funzioni dello strumento mediante il software gratuito, il sito web del produttore (lo strumento deve essere connesso, con un cavo PROXIMITY o di alimentazione RS / USB, o *Bluetooth*®).

Possibilità:

- Disattivare o attivare le funzioni desiderate
- Modificare l'accesso alle funzioni avanzate (messa in accesso diretto)

11. Connessione dello strumento

Lo strumento può essere connesso a una periferica mediante un cavo Proximity (RS o USB), o di POWER-RS e POWER-USB, o *Bluetooth*® Smart. Vedere pagina 2 per il collegamento dei cavi.

È possibile trasmettere i valori misurati e comandare lo strumento con dei retro-comandi predefiniti (elenco dei comandi principali, consultare il capitolo 12)

Nota:

In modalità Tolleranza, le spie dei limiti di tolleranza rimangono accese solo per pochi secondi mentre la misura si stabilizza. Resteranno accese in modo fisso se lo strumento è collegato e alimentato con il cavo POWER-RS e POWER-USB.

12. Elenco dei comandi principali

Selezione e configurazione

CHA+ / CHA-	Modifica direzione di misura
FCT0 ...9...A...F	Assegnazione funzione «preferito»
MM / IN	Modifica unità di misura
KEY0 / KEY1	Attiva / disattiva il blocco tastiera
MUL [+/-]xxx.xxxx	Modifica fattore di moltiplicazione
PRE [+/-]xxx.xxx	Modifica valore di preset
REF1 / REF2	Modifica del riferimento attivo
STO1 / STO0	Attiva / disattiva HOLD
TOL1 / TOL0	Attiva / disattiva le tolleranze
LCAL dd.mm.yy	Modifica data ultima calibratura
NCAL dd.mm.yy	Modifica data prossima calibratura
TOL +/-xxx.xxx +/-yyy.yyy +/-zzz.zzz	Inserimento valore nominale e limiti di tol. attuali
MIN / MAX / DEL / NOR	Selezione modalità MIN, MAX, Delta, Normale
CLE	Reinizializzazione del MIN, MAX o Delta
UNI1 / UNI0	Attiva / disattiva il cambio di unità
OUT1 / OUT0	Attiva / disatt. trasmissione dati continua
PRE ON / PRE OFF	Attiva / disatt. la funzione Preset
PRE	Richiamo del Preset
SET	Azzeramento
RES2 / RES3	Modifica risoluzione
BT0/BT1	Attiva / disattiva la modalità Bluetooth®
BTRST	Reinizializzazione dell'accoppiamento

Interrogazione

CHA?	Senso di misura?
FCT?	Funzione «preferito» attiva?
UNI?	Unità di misura attiva?
KEY?	Blocco tastiera?
MUL?	Fattore di moltiplicazione?
PRE?	Valore di preset?
REF?	Riferimento attivo?
STO?	Stato funzione HOLD?
TOL?	Valore dei limiti di tol. attuali?
LCAL?	Data ultima calibratura?
NCAL?	Data prossima calibratura?
?	Valore attuale (modalità Tol, valore seguito da <=>)
MOD?	Modalità attiva (MIN, MAX, Delta o Normale)?
SET?	Parametri principali dello strumento?
ID?	Codice d'identificazione dello strumento?
Funzioni di manutenzione	
BAT?	Stato batteria (BAT1=Ok, BAT0=batteria scarica)
OFF	Spegnim. completo (riattivazione mediante pulsante o RS)
RST	Reinizializzazione dello strumento
SBY	Messa in Stand by dello strumento (SIS)
VER?	Revisione e data del firmware
MAC?	Indirizzo MAC del modulo Bluetooth®

13. Specifiche

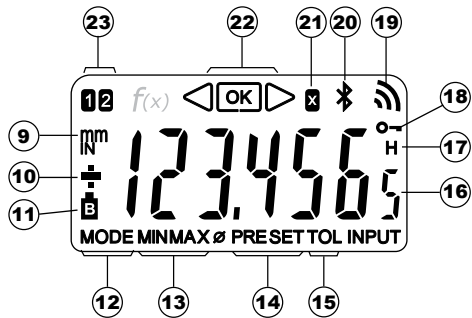
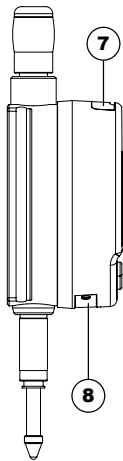
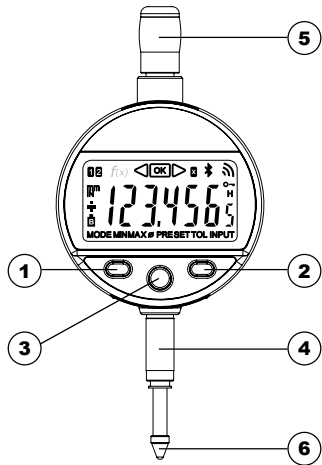

Campo di misura:	12.5mm	25mm	50mm	100mm	150mm	
Errore max (risoluzione 0,01 mm):	10µm	10µm	20µm	20µm	20µm	(±1 digit)
Errore max (risoluzione 0,001 mm):	3µm	4µm	5µm	6µm	10µm	
Errore max (risoluzione 0,0001 mm):	1.8µm	2.2µm	---	---	---	
Ripetibilità:	2µm 0.5µm (risoluzione 0.0001mm)					
Peso:	119g	123g	161g	208g	265g	
Forza di misura (standard):	0.65-0.9N	0.65-1.15N	1.25-2.7N	1.6-3.5N	2.2-5.7N	
Velocità max. di spostamento:	1.7m/s					
N. di misure al secondo:	misura: 10 mis/s modalità MIN/MAX: 20 mis/s					
Unità di misura:	metrica/inglese (Inch)					
Preset massimo (risoluzione 0,01 mm):	±9999.99 mm / ±399.9995 IN					
Preset massimo (risoluzione 0,001 mm):	±999.999 mm / ±39.99995 IN					
Preset massimo (risoluzione 0,0001 mm):	±99.9999 mm / ±3.999995 IN					
Sistema di misura:	Sistema Sylvac induttivo (brevettato)					
Alimentation:	1 batteria al litio 3 V, tipo CR2032, capacità 220 mAh					
Consumo medio:	73µA					
Autonomia media:	8.000 ore / Bluetooth® fino 3.650 ore					
Uscita dati:	compatibile RS232					
Portata	fino a 15 m (a seconda dell'ambiente)					
Temperatura operativa (stoccaggio):	da +5 a +40 °C (da -10 a +60 °C)					
Compatibilità elettromagnetica:	secondo EN 61326-1					
Specifica IP (secondo IEC60529):	IP 51 / IP 67 (in base al modello)					
Fissaggio e ingombro:	fissaggio Ø8h6 (3/8"), tasto di misura intercambiabile M2.5 (4-48-UNF) (secondo DIN 878)					



Description

1. Botón Modo
2. Botón Configuración
3. Botón « Favoritos »
4. Cañón de fijación Ø8 o 3/8"
5. Corona de elevación
6. Palpador de bola Ø2/M2.5 o 4-48-UNF
7. Alojamiento para cable Proximity
8. Alojamiento para batería o cable Power
9. Unidad de medida (mm/pulgadas)
10. Indicadores +/-
11. Batería baja
12. Indicación del menú Modo
13. Modo MIN/MAX/DELTA
14. Modo Preset
15. Modo Tolerancias
16. Visualización de 6 dígitos
17. Congelación del valor de medición
18. Bloqueo del botón
19. Envío de datos
20. Conexión *Bluetooth*® (depende de la versión)
21. Factor de multiplicación
22. Indicadores de tolerancia
23. Referencia activa

1. Funcionalidades del equipo

-  El equipo dispone de 2 modos de trabajo: funciones básicas (con acceso directo) y funciones avanzadas. Además de las funciones de configuración hay acceso a dos referencias de trabajo, en modo MIN, MAX y DELTA (TIR), en visualización de tolerancias o en la introducción de un factor de multiplicación distinto de 1:1. (ver cap. 3 y 4)
-  La tecla «favorito» atribuye un acceso directo a la función utilizada de manera principal (ver cap. 7)
-  Atribuye un valor predefinido, reinicializa el modo MIN/MAX, borra una selección y gestiona el apagado del equipo. Por defecto, el modo SIS permite apagar de manera automática sin pérdida de original (ver cap. 8)

- Personalización de las funciones

Es posible activar o desactivar ciertas funciones del equipo por RS232 (ver cap. 10)

- Parámetros de transmisión de datos

4800Bds, 7 bits, paridad par, 2 bits de parada

2. Arranque

Pulse un botón. En el primer empleo, el equipo pedirá seleccionar la unidad de medida deseada (\overline{mm} o *Inch*).
Seleccione... y mida
Para la conexión *Bluetooth®*, ver capítulo 5.

3. Funciones básicas

Cada pulsación breve sobre  permite acceder directamente a las funciones básicas:

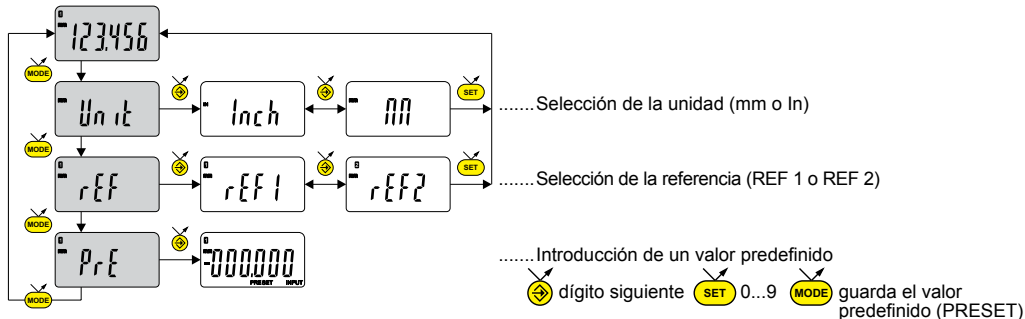

Observaciones: Es posible atribuir un valor predefinido diferente a cada una de las 2 referencias. También pueden atribuirse límites de tolerancia diferentes a las referencias 1 y 2.



4. Funciones avanzadas

Al pulsar prolongadamente (>2 seg) sobre **MODE** accederá a las funciones avanzadas. Pulsando brevemente en **MODE** accederá a la función deseada:

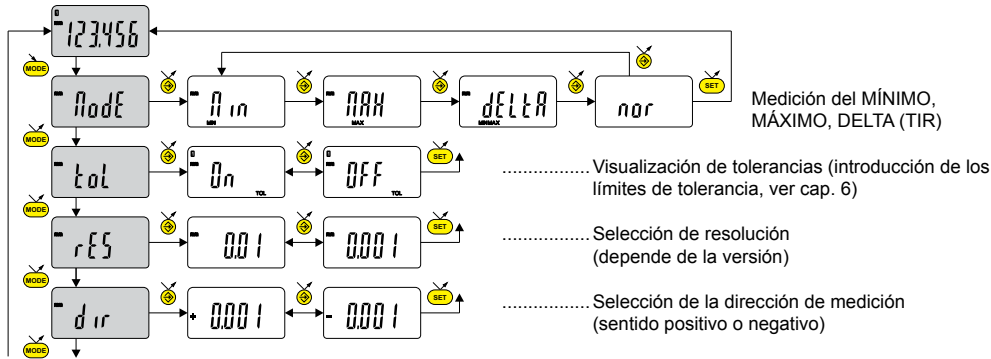

..... continuación

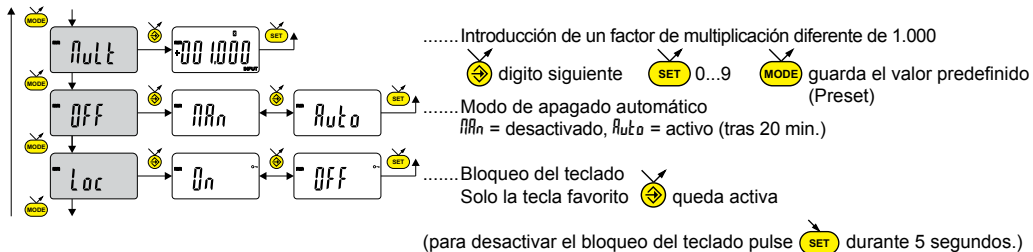

Observaciones:

También es posible mostrar los límites de tolerancia cuando el equipo trabaja en modo MIN, MAX o DELTA (TIR)

- Si el usuario no ha definido ningún límite de tolerancia, el instrumento mostrará los indicadores de límites de tolerancias ◀ OK ▶, pero sin activar los indicadores luminosos (rojo - verde - amarillo)

..... continuación

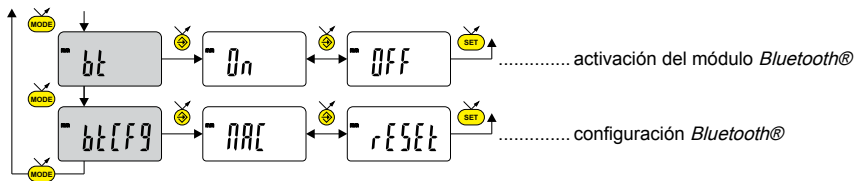

5. Configuración *Bluetooth*[®]

El procedimiento de conexión está pensado para que sea sencillo y se caracteriza por los 3 estados siguientes:

- 1° Símbolo ✖ apagadomodo desconectado
- 2° Símbolo ✖ parpadeantemodo detección
- 3° Símbolo ✖ encendidomodo conectado

Conexión:

- 1° Compruebe que la aplicación y el *Bluetooth*[®] Smart compatibles están activos (PC, unidad de medida).
- 2° Encienda el dispositivo. El módulo *Bluetooth*[®] está activo por defecto y el dispositivo es conectable durante 120 segundos (modo detección).

- 3° En cuanto se detecta el dispositivo, la conexión es automática. Si la conexión no se ha establecido durante los 120 segundos, reactive el módulo *Bluetooth®* con el menú *bt / On*
- 4° El dispositivo está listo para transmitir (modo conectado)

Emparejamiento :

El emparejamiento del dispositivo con el maestro es automático en la primera conexión. Para conectar un dispositivo a otro maestro (nuevo emparejamiento), hay que eliminar su información de emparejamiento desde el menú *bt [F9] / rEStt*.

5.1 Especificación *Bluetooth®*

Radiofrecuencia	2,4Ghz
Seguridad	128-bit AES
Robustez	FHSS
Latencia (conexión + envío de datos)	<6ms
Alcance	Espacio abierto: hasta 15m Entorno industrial: 1-5m
Autonomía	Hasta 5 meses Ex: 200'000 transmisiones @8h/día, 20días/mes, 2'000 datos/día

6. Introducción de los límites de tolerancia

Para introducir o modificar los límites de tolerancia seleccione el modo t_{ol} \rightarrow U_n y a continuación presione brevemente

en **MODE** :

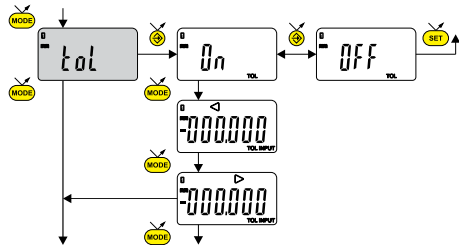

..... Introduzca el límite de tolerancia inferior \triangleleft

..... Introduzca el límite de tolerancia superior \triangleright

\rightarrow dígito siguiente **SET** 0...9 **MODE** guarda el valor predefinido (PRESET)

Observaciones :

- En el caso de medición de cotas de interior puede cruzar los indicadores (rojo y amarillo) invirtiendo el orden de introducción de los límites de tolerancia (límite inferior > límite superior).
- Es posible introducir límites de tolerancia diferentes en las REF1 y REF2.

7. Tecla favorito

Con la tecla «favorito» se accede directamente a una función predefinida y puede configurarse según las necesidades del usuario. Para atribuir una función a la tecla «favorito» pulse prolongadamente sobre  y seleccione la función deseada:

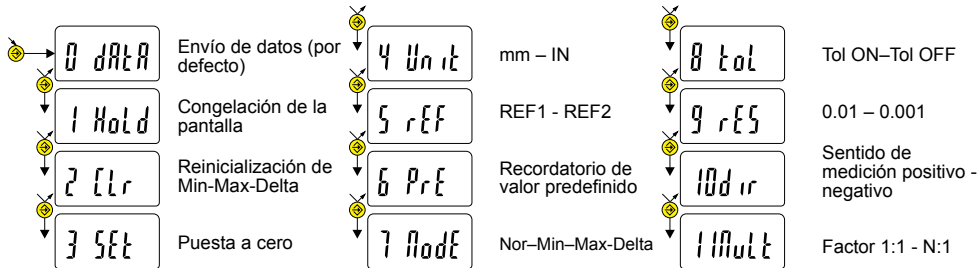

Validación de la selección: Pulsando prolongadamente en , o brevemente en  o en 

Observaciones: puede atribuirse también la función por RS232 con las teclas <FCT + N° de función>
ejemplo: Cambio de unidad de medida= <FCT4>

8. Apagado

El comparador hibernará automáticamente tras 20 minutos de inactividad salvo que el modo Auto OFF esté desactivado (ver Cap. 4, Funciones avanzadas)

Es posible forzar el modo de hibernación pulsando prolongadamente



sobre :

En modo hibernación el sensor conserva el valor original (modo SIS) y el equipo se reanuda automáticamente por un movimiento de la tecla de medición por control RS, o pulse un botón.

Es posible apagar el equipo en períodos largos en los que no se utiliza pero esto implicará una puesta a cero al arranque de nuevo (pérdida del origen):

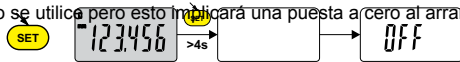

- Pulsar prolongadamente (> 4 seg) sobre :

9. Reinicialización del equipo

Los ajustes iniciales del equipo pueden restaurarse en cualquier momento pulsando prolongadamente (> 4 seg) y al mismo tiempo que

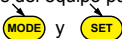

hasta que se muestre el mensaje *reset*.

El equipo conservará los ajustes de configuración (unidad y resolución) de emparejamiento y la última referencia activa.

10. Personalización del equipo

Es posible personalizar el acceso a las funciones de su equipo con el programa gratuito para más información, véase el sitio web del fabricante (requiere conexión de su equipo con cable Proximity o Power RS / USB, o *Bluetooth®*).

Esta aplicación permite:

- Desactivar o activar las funciones deseadas
- Modificar el acceso a las funciones avanzadas (acceso directo)

11. Conexión del equipo

El equipo puede conectarse a un periférico con un cable Proximity (RS o USB), o Power-RS (Power-USB) o *Bluetooth®* Smart. Consultar la página 2 para la conexión de los cables.

Los valores medidos pueden transmitirse y puede controlarse el instrumento con comandos predefinidos (lista de comandos principales en el cap. 12)

Observaciones :

En modo Tolerancia, los indicadores luminosos de los límites de tolerancia se iluminan sólo unos segundos cuando la medición se ha estabilizado. Sin embargo se mantendrán iluminados si el instrumento está conectado y recibe alimentación con el cable Power RS (USB).

12. Lista de comandos principales

Selección y configuración

CHA+ / CHA-	Cambio de dirección de medición
FCT0 ...9...A...F	Atribución de función «favorito»
MM / IN	Cambio de unidad de medida
KEY0 / KEY1	Activa / desactiva el bloqueo de teclado
MUL [+/-]xxx.xxxx	Modificación del factor de multiplicación
PRE [+/-]xxx.xxx	Modificación del valor predefinido
REF1 / REF2	Cambio de la referencia activa
STO1 / STO0	Activa / desactiva el HOLD
TOL1 / TOL0	Activa / desactiva las tolerancias
LCAL dd.mm.yy	Modifica fecha de última calibración
NCAL dd.mm.yy	Modifica fecha de próxima calibración
TOL +/-xxx.xxx +/-yyy.yyy +/-zzz.zzz	Introducción del valor nominal y de los límites de tol. actuales
MIN / MAX / DEL / NOR	Selección del modo MIN, MAX, Delta, Normal
CLE	Reinicio del MIN, MAX o Delta
UNI1 / UNIO	Activa / desactiva el cambio de unidad
OUT0	Activa / desact. transmisión continua de datos
PRE ON / PRE OFF	Activa / desactiva la función Preset
PRE	Recordatorio del Preset
SET	Puesta a cero
RES2 / RES3	Cambio de resolución
BT0/BT1	Activa / desactiva el modo Bluetooth®
BTRST	Reinicialización del emparejamiento

Pregunta

CHA?	¿Sentido de medición?
FCT?	¿Función «favorito» activada?
UNI?	¿Unidad de medida activada?
KEY?	¿Bloqueo de teclado?
MUL?	¿Factor de multiplicación?
PRE?	¿Valor predefinido?
REF?	¿Referencia activa?
STO?	¿Estado de la función HOLD?
TOL?	¿Valor de límites de tol. actuales?
LCAL?	¿Fecha de última calibración?
NCAL?	¿Fecha de próxima calibración?
?	¿Valor actual (modo Tol, valor seguido de <=>)?
MOD?	¿Modo activo? (MIN, MAX, Delta o Normal)
SET?	¿Configuración principal del instrumento?
ID?	¿Código de identificación del instrumento?OUT1 /
Funciones de mantenimiento	
BAT?	Estado batería (BAT1=Ok, BAT0=batería baja)
OFF	Apagado completo (arranque con botón o RS)
RST	Reinicialización del equipo
SBY	Hibernación del equipo (SIS)
VER?	Revisión y fecha del firmware.
MAC?	Dirección MAC del módulo Bluetooth®

13. Specifications

Alcance de la medición:	12.5mm	25mm	50mm	100mm	150mm	
Error máx. (escala 0,01mm):	10µm	10µm	20µm	20µm	20µm	(±1 digit)
Error máx. (escala 0,001mm):	3µm	4µm	5µm	6µm	10µm	
Error máx. (escala 0,0001mm):	1.8µm	2.2µm	---	---	---	
Repetibilidad:	2µm 0.5µm (escala 0.0001mm)					
Peso:	119g	123g	161g	208g	265g	
Fuerza de medición (estándar):	0.65-0.9N	0.65-1.15N	1.25-2.7N	1.6-3.5N	2.2-5.7N	
Velocidad máxima de desplazamiento:	1.7m/seg.					
N1 de mediciones por segundo:	medición: 10 mes/s modo MIN/MAX: 20 med/seg.					
Unidad de medida:	métrico / imperial (pulgadas)					
Preset máximo (escala 0,01mm):	±9999.99 mm / ±399.9995 IN					
Preset máximo (escala 0,001mm):	±999.999 mm / ±39.99995 IN					
Preset máximo (escala 0,0001mm):	±99.9999 mm / ±3.999995 IN					
Sistema de medida	Sylvac inductive system (patentado)					
Alimentación:	1 batería litio 3V, tipo CR2032, capacidad 220mAh					
Consumo medio:	73µA					
Autonomía media:	8'000 hours / Bluetooth® hasta 3'650 horas					
Salida de datos:	compatible RS232					
Alcance	hasta 15m (depende del entorno)					
Temperatura de trabajo (almacenamiento):	+5 hasta +40°C (-10 hasta +60°C)					
Compatibilidad electromagnética:	según EN 61326-1					
Especificación IP (según IEC60529):	IP 51 / IP 67 (depending on model)					
Fijación y volumen:	fijación Ø8h6 (3/8"), tecla de medición intercambiable M2.5 (4-48-UNF) (según DIN 878)					

CERTIFICATE OF CONFORMITY

We certify that this instrument has been manufactured in accordance with our Quality Standard and tested with reference to masters of certified traceability by the National Office of Metrology.

CERTIFICAT DE CONFORMITE

Nous certifions que cet instrument a été fabriqué et contrôlé selon nos normes de qualité et en référence avec des étalons dont la traçabilité est reconnue par l'office national de métrologie.

QUALITÄTSZEUGNIS

Wir bestätigen, dass dieses Gerät gemäss unseren internen Qualitätsnormen hergestellt wurde und mittels Normalen mit anerkannter Rückverfolgbarkeit, kalibriert durch das Nationalamt für Metrologie, geprüft worden ist.

CERTIFICATO DI CONFORMITÀ

Con il presente si certifica che questo strumento è stato prodotto secondo il nostro standard sulla qualità e controllato rispetto a campioni di riferibilità riconosciuta dall'ufficio nazionale di metrologia

CERTIFICADO DE CONFORMIDAD

Certificamos que este instrumento ha sido fabricado conforme a nuestras normas de calidad y ha sido controlado en relación con patrones de trazabilidad reconocida por la oficina nacional de metrología.

Calibration certificate

Because we make our instruments in batches, you may find that the date on your calibration certificate is not current. Please be assured that your instruments are certified at point of production and then held in stock in our warehouse in accordance with our Quality Management System ISO 9001. Re-calibration cycle should start from date of receipt.

Certificat d'étalonnage

En raison de la fabrication de nos instruments par lots de production, il est possible que la date de votre certificat d'étalonnage ne soit pas actuelle. Nous garantissons que nos instruments sont certifiés au moment de leur fabrication puis stockés conformément à notre système de gestion de la qualité ISO 9001. Le cycle de réétalonnage peut commencer à partir de la date de réception.

Zertifikat

Da wir unsere Instrumente in Serien herstellen, kann es sein, dass das Datum auf dem Zertifikat nicht aktuell ist. Die Instrumente sind jedoch ab der Herstellung zertifiziert und werden dann gemäß unserem Qualitätsmanagementsystem ISO 9001 in unserem Lager aufbewahrt. Der Nachkalibrierungszyklus kann ab dem Empfangsdatum beginnen.

Certificado de calibración

Puesto que fabricamos nuestros instrumentos por lotes, puede que la fecha de su informe de prueba / certificado de calibración no esté al día. Asegúrese de que los instrumentos estén certificados en nuestro lugar de producción y estén almacenados en nuestro almacén conforme a nuestro sistema de control de calidad ISO 9001. El ciclo de recalibración puede empezar a partir de la fecha de recepción.

Certificato di taratura

Considerata la nostra produzione in serie di strumenti, è possibile verificare che la data di produzione sul rapporto di prova / certificato di taratura non è attuale. Accertarsi che gli strumenti siano correttamente certificati dalla nostra produzione e che sono conservati in stock presso il nostro magazzino secondo il sistema di gestione della qualità ISO 9001. Il ciclo di nuova taratura può essere avviato dalla data di ricezione.

FCC labeling



FCC ID: Q96289

NOTICE:

Changes or modifications made to this equipment not expressly approved by Sylvac may void the FCC authorization to operate this equipment.

NOTICE :

This device complies with Part 15 of the FCC Rules. Operation is subject to the following two conditions.

(1) this device may not cause harmful interference, and

(2) this device must accept any interference received, including interference that may cause undesired operation.

NOTE :

This equipment has been tested and found to comply with the limits for a Class A digital device, pursuant to Part 15 of the FCC Rules. These limits are designed to provide reasonable protection against harmful interference when the equipment is operated in a commercial environment. This equipment generates, uses, and can radiate radio frequency energy and, if not installed and used in accordance with the instruction manual, may cause harmful interference to radio communications. Operation of this equipment in a residential area is likely to cause harmful interference in which case the user will be required to correct the interference at his own expense.

Radiofrequency radiation exposure Information :

This equipment complies with FCC radiation exposure limits set forth for an uncontrolled environment. This equipment should be installed and operated with minimum distance of 20 cm between the radiator and your body.

This transmitter must not be co-located or operating in conjunction with any other antenna or transmitter.



ROHS 2002/95/CE

Changes without prior notice

Sous réserve de toute modification

Änderungen vorbehalten

Soggetto a modifica senza preavviso

Reservados los derechos de modificación sin previo aviso

Edition :2013.10 / 681.289.01-100