



BOWERS

XTE Digital Bluetooth®

Bore Gauge

Operating Instructions

IP67 Electronics

XTE Digital Bluetooth®

Alésomètre

Notice d'utilisation

Electronique IP67

XTE Digital Bluetooth®

Bohrungslehre

Bedienungsanleitung

IP67 Elektronik

XTE Digital Bluetooth®

Alesmetro

Istruzioni d'uso per

IP67 L'elettronica

XTE Digital Bluetooth®

Micrómetro de interiores

Instrucciones de funcionamiento

IP67 Electrónica



sylvac

CONTENTS

TABLE DES MATIERES

INHALTSVERZEICHNIS

Measuring Operation	Mode opératoire	Messung	5
LCD Display	Affichage LCD	LCD Anzeige	7
Button Functions	Fonctions des boutons	Tastenfunktionen	8
ON / OFF	Marche / Arrêt	Ein / Aus	9
Reset Parameters	Remise à zéro	Parameter reset	9
Set Mode	Mode "SET"	Set Modus	10
Reference Mode	Mode "REFERENCE"	Referenz-Modus	10
Preset Mode	Mode "PRESET"	Preset Modus	11
Unit	Unités de mesure	Messeinheit	12
Resolution	Résolution	Auflösung	12
Auto switch Off	Touche auto. Marche/Arrêt	Automatisches Ausschalten	12
Hold Indicator	Indicateur de gel de l'affichage	Halten-Anzeige	13
Hold measured value	Blocage de la mesure affichage	Einfrieren des Messwertes	13
Bluetooth® Mode	Mode "BLUETOOTH®"	Bluetooth® Modus	14
Bluetooth® Configuration	Configuration Bluetooth®	Bluetooth®-Konfiguration	14
Bluetooth® Specifications	Spécifications Bluetooth®	Bluetooth®-Funktion	15
Data Transmission	Transmission des données	Datenübertragung	20
Changing Battery	Changement de la pile	Batteriewechsel	21
IP67 Protection	Protection IP67	IP67 - Schutz	22
Warranty	Garantie	Garantie	22
Bluetooth® Brazil Certification			23
Bluetooth® Mexico Certification			23
Bluetooth® USA / Canada Certification			24
Bluetooth® South Korea Certification			25
Bluetooth® Japan Certification			25
Bluetooth® Taiwan Certification			25

CONTENUTO**CONTENIDO**

Operazione di misura	Operación de medición	6
Display LCD	Pantalla LCD	7
Funzioni dei pulsanti	Funcionamiento de teclas	8
ON / OFF	Encender / Apagar	9
Resettaggio parametri	Reinicio de parámetros	9
Modalità set	Modo Set	10
Modalità riferimento	Modo Referencia	10
Modalità preset	Modo Preset	11
Unità	Unidad	12
Risoluzione	Resolución	12
Spegnimento automatico	Auto apagado	12
Indicazione del congelamento della lettura	Indicador de bloqueo	13
Congelamento del valore di misura	Congelar el valor medido	13
Modalità Bluetooth®	Modo Bluetooth®	14
Configurazione Bluetooth®	Configuración de Bluetooth®	14
Specifiche Bluetooth®	Especificación Bluetooth®	18
Trasmissione dati	Transición de datos	20
Sostituzione della batteria	Cambio de la batería	21
Protezione IP67	Protección IP67	22
Garanzia	Garantía	22

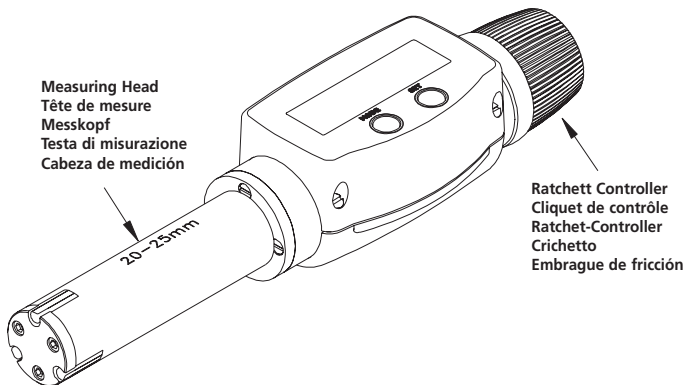

The gauge should be placed into the appropriate measuring ring to set or check the calibration. Place the gauge into the bore to be measured, ensuring that the anvils sit squarely on the surface of the bore. In each case twist the ratchet controller three times to achieve a set pressure on the anvils.

When sets with alternative measuring heads are used, make sure that the head is screwed firmly onto the electronic reading head.

The surfaces between the mating parts should be clean and free from grit or swarf before assembly.

Etalonner le micromètre en utilisant la bague appropriée. Placer le micromètre dans l'alésage tout en s'assurant que les touches de la tête de mesure sont bien en contact avec la surface de l'alésage. Tourner le cliquet sur 3 tours complets afin d'appliquer la pression optimale au niveau des touches.

En cas d'utilisation avec des têtes de mesure interchangeables, s'assurer que la tête de mesure est fermement vissée sur l'unité de mesure. Les surfaces en contact doivent être propres (touches exemptes de graisses, poussières..etc.).

Das Gerät sollte in einem passenden Einstellung kalibriert bzw. die Kalibrierung überprüft werden. Beim Einführen in die Bohrung darauf achten, daß die Messeinsätze rechtwinklig in der Bohrungsfäche stehen. Die Ratsche sollte mindestens dreimal angedreht werden, damit der richtige Messdruck an den Einsätzen gewährleistet ist.

Beim Austausch von Messköpfen, immer darauf achten, daß der Kopf fest auf den Halter aufgeschraubt ist. Dabei müssen die Anlageflächen sauber und frei von Fett und Schmutz sein.

OPERAZIONE DI MISURA

Lo strumento deve essere posizionato all'interno dell'anello di riscontro appropriato al campo di misura della testa, per azzerarlo o controllare la sua taratura.

Posizionare il micrometro nel foro da misurare, assicurandosi che le incudini poggino correttamente sulle pareti del foro stesso. Ad ogni modo, per sicurezza, girare a il cricchetto tre volte prima di leggere la misura, in modo da esercitare la giusta pressione.

Quando si cambia spesso testa, controllare che questa sia correttamente avvitata in battuta all'unità elettronica, e che tra le superfici a contatto non ci siano sporco o residui prima di procedere all'assemblaggio.

OPERACIÓN DE MEDICIÓN

Introduzca el micrómetro en el anillo patrón adecuado y realice una medición usando el embrague de fricción, compruebe que la lectura es igual a la del anillo y sino realice la calibración del instrumento.

Introduzca ahora el micrómetro en el orificio a medir. Gire el embrague de fricción para medir el agujero y compruebe que los palpadores están correctamente apoyados en 3 puntos. Cuando haga tope gire el embrague 3 veces para asegurar una presión uniforme.

Cuando se utilizan juegos con varios cabezales de medición, asegúrese de que la cabeza se enrosca firmemente sobre la unidad de lectura electrónica. Las superficies de contacto deben estar limpias y libres de grasa y suciedad.

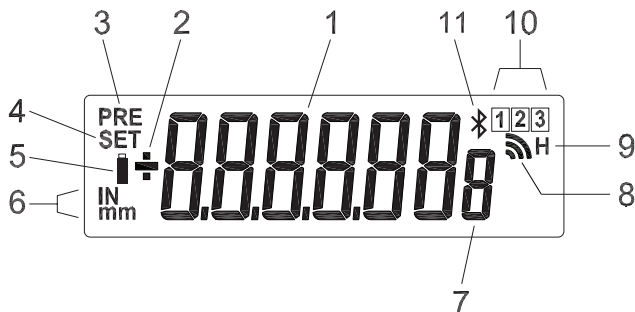

Description of LCD

1. Measured Value
2. Positive / Negative sign
3. Indicator of Preset Mode
4. Indicator of Set
5. Battery life warning display
6. Indicator of Measuring Unit
7. Display 0,00005 inch
8. Data send indicator
9. Hold Indicator
10. Indicator of Reference Mode
11. Indicator of Bluetooth®

Description de l'affichage LCD

1. Valeur mesurée
2. Signe positif / négatif
3. Affichage de la fonction "Preset"
4. Affichage de la fonction "Set"
5. Indicateur de pile faible
6. Indicateur d'unité de mesure
7. Affichage 0,00005 pouce
8. Indicateur de transmission
9. Indicateur de gel de l'affichage
10. Affichage de la fonction "Référence"
11. Indicateur Bluetooth®

LCD-Beschreibung

1. Messwert
2. Positiv / Negativ-Zeichen
3. Preset Modus-Anzeige
4. Einstellen-Anzeige
5. Batterieanzeige
6. Messeinheit-Anzeige
7. Auflösung 0,00005 inch
8. Datenübertragungsanzeige
9. Halten-Anzeige
10. Referenzmodus-Anzeige
11. Bluetooth®-Anzeige

Descrizione del Display

1. Valore misurato
2. Segno positivo / negativo
3. Indicazione della modalità Preset
4. Indicazione della modalità Set
5. Indicazione batterie scariche
6. Indicazione dell'unità di misura in uso
7. Display 0,00005 pollici
8. Indicatore invio dati
9. Indicazione del congelamento della lettura
10. Indicazione modalità riferimento
11. Indicazione della Bluetooth®

Descrición de la pantalla digital

1. Valor de la medición
2. Signo positivo / negativo
3. Modo preselección
4. Modo ajuste
5. Indicador de la batería
6. Unidad de medición
7. Pantalla 0,00005 pulgadas
8. Indicador de envío de datos
9. Indicador de bloqueo
10. Modo Referencia
11. Indicador de Bluetooth®

BUTTON FUNCTIONS FONCTIONS DES BOUTONS TASTENFUNKTIONEN
 FUNZIONI DEI PULSANTI FUNCIONAMIENTO DE TECLAS

How to use buttons Synoptique fonctionnel Tastenbedienung Come usare i pulsanti Funciones de las teclas

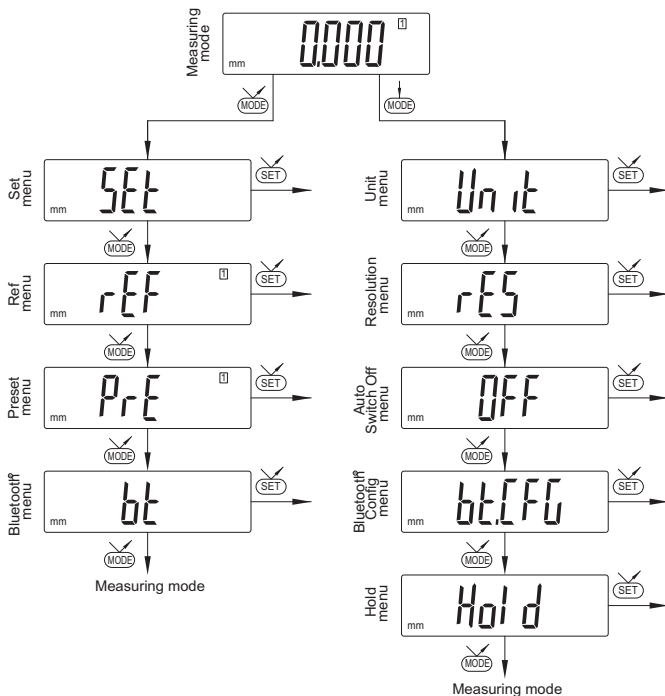
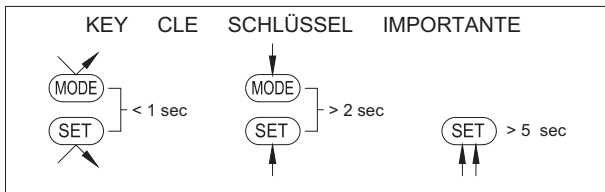

ON / OFF
ON / OFF

MARCHE / ARRET
ENCENDER / APAGAR

EIN / AUS

Switch On
Activer
Einschalten
Accendere
Encender



Switch Off
Désactiver
Ausschalten
Spegner
Apagar

Wake Up
Sortie du mode "veille"
Aufwachen
Sveglia
Despertarse



Standby
Veille
Bereitschaft
En espera

Off
Désactivé
Aus
Spento
Apagado

RESET PARAMETERS
RESETTAGGIO PARAMETRI

REMISE A ZERO
REINICIO DE PARÁMETROS

PARAMETER RESET

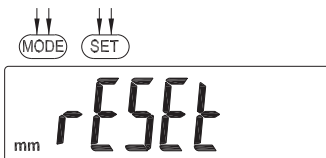

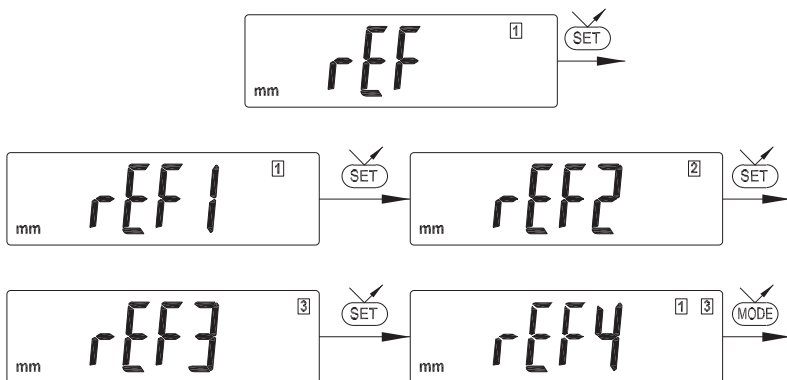
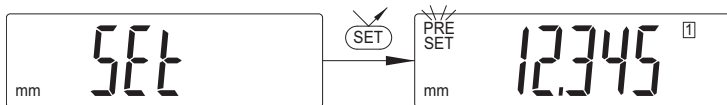

PRESET MODE
MODALITA' PRESET

MODE "PRESET"
MODO PRESET

PRESET MODUS

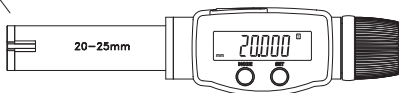
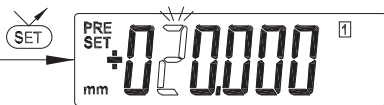
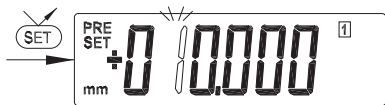

UNIT

UNITE

MESSEINHEIT

UNITÀ

UNIDAD

mm Unit

SET

IN Inch

SET

mm

MODE

RESOLUTION
RISOLUZIONE

RESOLUTION
RESOLUCIÓN

AUFLÖSUNG

mm RES

SET

mm 0.01

SET

mm 0.001

MODE

AUTO SWITCH OFF

TOUCHE AUTO. MARCHE/ARRET

AUTOMATISCHES AUSSCHALTEN

SPENGNIMENTO AUTOMATICO

AUTO APAGADO

mm OFF

SET

mm

MAN

SET

mm

Auto

MODE

Manual switch Off
Eteindre manuellement
Manuelle Abschaltung
Spegnimento manuale
Apagado manual

Auto switch off after approximately 4 hours
Arrêt automatique après environ 4 heures
Automatische Abschaltung nach ca. 4 Stunden
Spegnimento automatico dopo circa 4 ore
Apagado automático después de aproximadamente 4 horas

HOLD INDICATOR INDICATEUR DE GEL DE L'AFFICHAGE HALTEN-ANZEIGE
INDICAZIONE DEL CONGELAMENTO DELLA LETTURA INDICADOR DE BLOQUEO

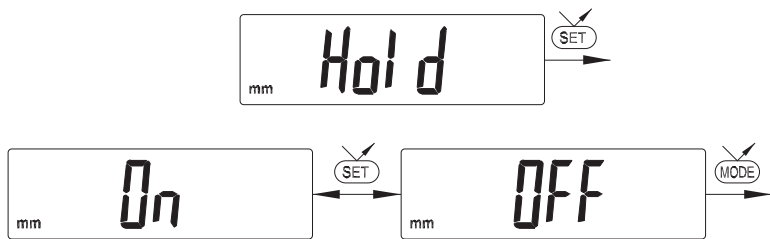

HOLD MEASURED VALUE BLOCAGE DE LA MESURE AFFICHAGE
EINFRIEREN DES MESSWERTES CONGELAMENTO DEL VALORE DI MISURA
CONGELAR EL VALOR MEDIDO

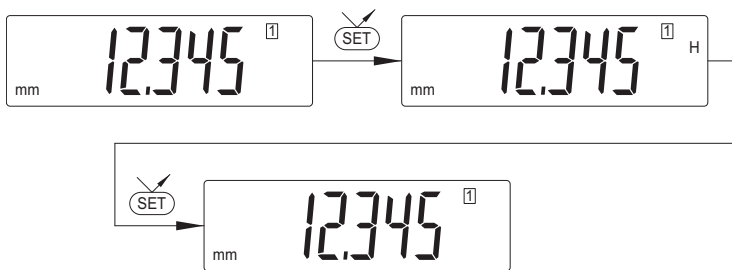

BLUETOOTH® MODE
MODALITÀ BLUETOOTH®

MODE "BLUETOOTH®"
MODO BLUETOOTH®

BLUETOOTH® MODUS

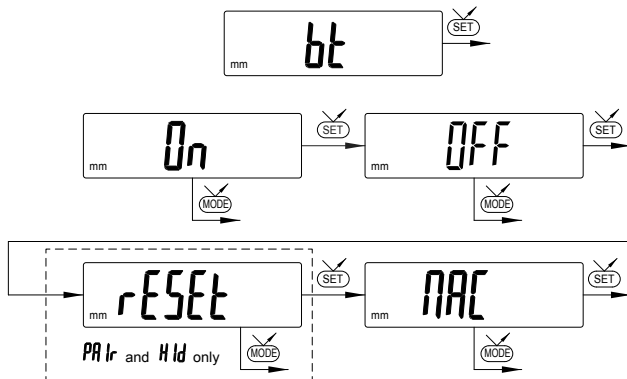

BLUETOOTH® CONFIGURATION
BLUETOOTH® KONFIGURATION
CONFIGURACIÓN BLUETOOTH®

CONFIGURATION BLUETOOTH®
CONFIGURAZIONE BLUETOOTH®

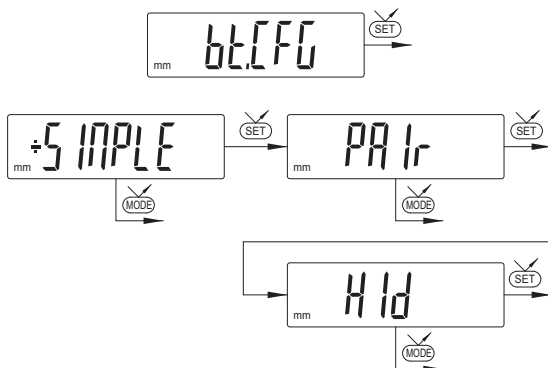

BLUETOOTH® CONFIGURATION

CONNECTION PROCEDURE

Symbol  off.....disconnected mode

Symbol  blinking.....advertising mode

Symbol  on.....connected mode

The following options can be selected to control the Bluetooth® module.

On Enable Bluetooth® module (start advertising mode).

OFF Disable Bluetooth® module (terminate active connection).

rESEt Clear pairing information.

MAC Display the MAC (Media Access Control) address.

Three Bluetooth® profiles are available.

S INP L E Profile without pairing (default).

PA Ir Paired and secured profile.

Hi d Virtual keyboard mode (compatible with recent equipment without driver installation).

Note:

- Bluetooth® pairing information is cleared when the profile is changed.

Connection:

1. Activate Bluetooth® compatible software and hardware (Master : PC, Display Unit).
2. Start the instrument. By default the Bluetooth® module is active and the instrument is available for connection (advertising mode).
3. If no connection is established during the advertisement period reactivate the Bluetooth® module using the *bt / On* menu.
4. Instrument is ready to communicate (connected mode).

Only with paired profile:

Pairing with master is automatically done at first connection.

To connect the instrument to a new master (new pairing), pairing information on the instrument must be cleared using the *bt / rESEt* menu.

BLUETOOTH® SPECIFICATIONS

Frequency Band	2.4 GHz (2.402 - 2.480 GHz)
Modulation	GFSK (Gaussian Frequency Shift Keying)
Max. output power	Class 3: 1mW (0dBm)
Range	Open space: up to 15 m Industrial environment: 1-5 m
Battery life	Continuous : up to 2 months - Always connected with 4 values / sec. Saver : up to 5 months - The instrument sends value only when the position has changed. Blind/Push : up to 7 months - Value is sent from the instrument (button) or requested from the computer.

Other specifications on the manufacturer's website.

CONFIGURATION BLUETOOTH®

PROCÉDURE DE CONNEXION

Symbole  éteint.....mode déconnecté

Symbole  clignote.....mode découverte

Symbole  allumé.....mode connecté

Les options suivantes peuvent être sélectionnées pour contrôler le module Bluetooth®.

On Activer le module Bluetooth® (démarrer le mode découverte).

OFF Désactiver le module Bluetooth® (terminer la connexion active).

rESEt Effacer les informations d'appariage.

MAC Afficher l'adresse MAC (Media Access Control).

Trois profils Bluetooth® sont disponibles.

SIMPLE Profil non appairé (par défaut).

PAIR Profil appairé et sécurisé.

HiD Mode clavier virtuel (compatible avec un équipement récent sans installation d'un pilote).

Remarque:

- Les informations d'appariage Bluetooth® sont effacées lorsque le profil est modifié.

Connexion:

1. S'assurer que l'application et le matériel Bluetooth® compatibles sont actifs (PC, unité de mesure).
2. Démarrer l'instrument. Par défaut le module Bluetooth® est actif et l'instrument est connectable (mode découverte).
3. Dès que l'instrument est détecté la connexion est automatique. Si la connexion n'a pas été établie pendant que l'instrument se trouvait en mode découverte, réactiver le module Bluetooth® via le menu *bt / On*.
4. L'instrument est prêt à transmettre (mode connecté).

Seulement avec le profil d'appariage:

L'appariage de l'instrument avec le maître se fait automatiquement à la première connexion.

Pour connecter un instrument à un nouveau maître (nouvel appariage), les informations d'appariage doivent être effacées via le menu *bt / rESEt*.



SPÉCIFICATION BLUETOOTH®

Bande de fréquence	2.4 GHz (2.402 - 2.480 GHz)
Modulation	GFSK (Gaussian Frequency Shift Keying)
Puissance de sortie max.	Class 3: 1mW (0dBm)
Portée	Espace ouvert : jusqu'à 15 m Environnement industriel : 1-5 m
Autonomie	Continuus : jusqu'à 2 mois - Toujours connecté avec 4 valeurs / sec. Saver : jusqu'à 5 mois - L'instrument envoie la valeur quand la position change. Blind/Push : jusqu'à 7 mois - Le valeur est envoyée de l'instrument (bouton) ou demandée par ordinateur.

Autre spécifications sur le site du fabricant.

BLUETOOTH® - KONFIGURATION

VERBINDUNGSVERFAHREN

- Kein  Symbol.....keine Verbindung
Blinkendes  Symbol.....bereit zur Verbindung
Stehendes  Symbol.....Verbindung hergestellt

Zur Konfiguration des Bluetooth®-Moduls stehen die folgenden Optionen zur Verfügung:

- On* Aktiviert das Bluetooth®-Modul (Instrument kann gefunden werden).
OFF Deaktiviert das Bluetooth®-Modul (aktive Verbindung wird getrennt).
rESEt Hebt die Bluetooth®-Kopplung auf.
MAC Zeigt die MAC (Media Access Control) - Adresse an.

Drei Bluetooth®-Profile stehen zur Auswahl:

- SIMPLE* Profil ohne Kopplung
PAIr Profil mit Kopplung und Verschlüsselung.
HiD Virtuelle Tastatur (Kompatibel mit aktuellen Geräten ohne Installation eines Treibers).

Anmerkung:

- Beim Wechsel des Profils wird die Bluetooth®-Kopplung aufgehoben.

Verbindungsaufbau:

1. Stellen Sie sicher, dass die Bluetooth® Anwendung und das Gerät kompatibel und aktiv sind (PC, Messeinheit).
2. Schalten Sie das Instrument ein. Die Bluetooth®-Funktion ist standardmässig aktiviert und das Instrument kann verbunden werden (Verbindung wird gesucht).
3. Wurde keine Verbindung hergestellt während das Instrument sichtbar war, aktivieren Sie Bluetooth® erneut über das Menü *bt / On*.
4. Das Gerät ist bereit zum Senden (Verbindung hergestellt).

Kopplung:

Die Kopplung des Instruments mit dem Master erfolgt automatisch bei der ersten Verbindung. Um das Instrument mit einem neuen Master zu verbinden (neue Kopplung), muss die Kopplung über das Menü *bt / rESEt* gelöscht werden.

TECHNISCHE DATEN DER BLUETOOTH® -FUNKTION

Frequenzband	2.4 GHz (2.402 - 2.480 GHz)
Modulation	GFSK (Gaussian Frequency Shift Keying)
Max. Ausgangsleistung	Klasse 3: 1mW (0dBm)
Reichweite	Im Freien : bis 15 m Industrieumgebung : 1-5 m
Autonomie	Continuous : bis zu 2 Monaten (Immer verbunden mit 4 Werten / sek). Saver : bis zu 5 Monaten (Das Gerät senet die Werte nur wenn die Position geändert hat). Blind/Push : bis zu 7 Monaten (Der Wert wird von dem Gerät gesendet (Taste) oder vom Computer angefordert).

Weitere Spezifikationen auf der Website des Herstellers.

CONFIGURAZIONE BLUETOOTH®

PROCEDURA DI COLLEGAMENTO

Simbolo  spentomodalità scollegata

Simbolo  lampeggiantemodalità scoperta

Simbolo  accesomodalità collegata

È possibile selezionare le seguenti opzioni per controllare il modulo Bluetooth®.

On Attivarne il modulo Bluetooth® (avviare la modalità di ricerca).

OFF Disabilita il modulo Bluetooth® (disattiva la connessione attiva).

RESET Cancellare le informazioni di accoppiamento.

MAC Visualizza l'indirizzo MAC (Media Access Control).

Sono disponibili tre profili Bluetooth®.

SIMPLE Profilo non accoppiato (per impostazione predefinita).

PAIR Profilo accoppiato e sicuro.

HID Modalità tastiera virtuale (compatibili con apparecchiature più recenti senza l'installazione del driver).

Nota:

- Le informazioni Bluetooth® vengono cancellate quando il profilo viene modificato.

Connessione:

1. Assicurarsi che l'applicazione e il l'apparecchio Bluetooth® compatibili siano attivi (PC, unità di misura).
2. Avviare lo strumento. Come impostazione predefinita il modulo Bluetooth® è attivo e lo strumento è collegabile (modalità scoperta).
3. Da quando lo strumento è rilevato il collegamento è automatico. Se la connessione non è stata stabilita mentre lo strumento è in modalità di rilevazione, riattivare il modulo Bluetooth® mediante il menu **bt / On**.
4. Lo strumento è pronto alla trasmissione (modalità collegata).

Accoppiamento:

L'accoppiamento dello strumento con la periferica avviene automaticamente all'avvio.

Per collegare uno strumento a una nuova periferica (nuovo accoppiamento) è necessario cancellare le informazioni di accoppiamento mediante il menu **bt / RESET**.

SPECIFICHE BLUETOOTH®

Banda di frequenza	2.4 GHz (2.402 - 2.480 GHz)
Modulazione	GFSK (Gaussian Frequency Shift Keying)
Potenza massima in uscita	Classe 3: 1mW (0dBm)
Portata	Spazio aperto : fino a 15 m Ambiente industriale : 1-5 m
Autonomia	Continuous : fino a 2 mesi (sempre connessi con i 4 valori / sec). Saver : fino a 5 mesi (Lo strumento invia valore solo quando la posizione è cambiata). Blind/Push : fino a 7 mesi (valore viene inviato dal (pulsante strumento) o richiesto dal computer).

Altre specifiche sul sito del produttore.

CONFIGURACIÓN - BLUETOOTH®

PROCEDIMIENTO DE CONEXIÓN

Símbolo  apagadomodo desconectado

Símbolo  parpadeantemodo detección

Símbolo  encendidomodo conectado

Se pueden seleccionar las siguientes opciones para controlar el módulo Bluetooth®.

On Habilitar el módulo Bluetooth® (iniciar el modo de advertencia).

OFF Desactiva módulo Bluetooth® (terminar la coexión activa).

rESEt Eliminar su información de emparejamiento.

MAC Muestra la dirección MAC (Media Access Control).

Tres perfiles de Bluetooth® están disponibles.

SIMPLE Perfil no apareado (por defecto).

PAIR Perfil apareado y seguro.

Hid Modo teclado virtual (compatible con equipos recientes sin instalación del controlador).

Observaciones:

- La información de Bluetooth® se borra cuando se cambia el perfil.

Conexión:

1. Compruebe que la aplicación y el Bluetooth® compatibles están activos (PC, unidad de medida).
2. Encienda el dispositivo. El módulo Bluetooth® está activo por defecto y el dispositivo es conectable (modo detección).
3. En cuanto se detecta el dispositivo, la conexión es automática. Si la conexión no se establece, durante que el instrumento se encuentre en modo búsqueda, reactivar el módulo Bluetooth® via el menú *bt / On*.
4. El dispositivo está listo para transmitir (modo conectado).

Sol con perfil emparejamiento:

El perfil del dispositivo con el maestro es automático en la primera conexión.

Para conectar un dispositivo a otro maestro (nuevo emparejamiento), hay que eliminar su información de emparejamiento desde el menú *bt / rESEt*.

ESPECIFICACIÓN BLUETOOTH®

Banda de frecuencia	2.4 GHz (2.402 - 2.480 GHz)
Modulación	GFSK (Gaussian Frequency Shift Keying)
Potencia máxima de salida	Clase 3: 1mW (0dBm)
Alcance	Espacio abierto : hasta 15 m Entorno industrial : 1-5 m
Autonomía	Continuous : hasta 2 meses (siempre conectados con 4 valores / seg). Saver : hasta 5 meses (El instrumento envía valor sólo cuando la posición ha cambiado). Blind/Push : hasta 7 meses (Valor se envía desde el (botón de instrumento) se puede solicitar a la computadora).

Otras especificaciones sobre el sitio web del fabricante.

Proximity connector

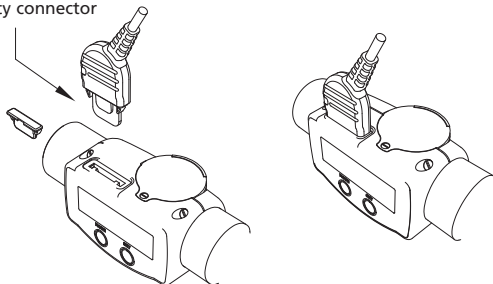

Data output: RS232 compatible / Bluetooth® 4.0

CHANGING BATTERY CHANGEMENT DE LA PILE BATTERIEWECHSEL
SOSTITUZIONE DELLA BATTERIA CAMBIO DE LA BATERÍA

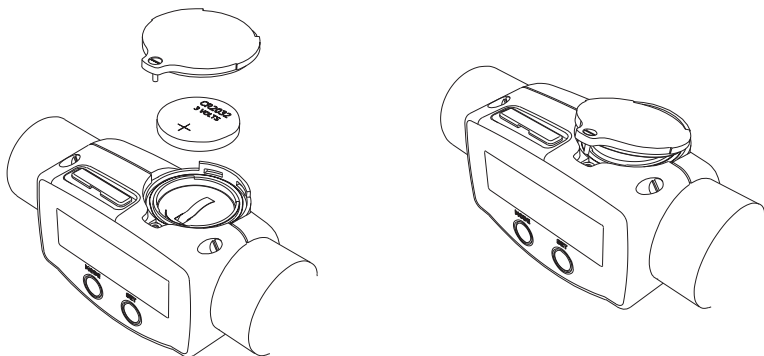

CR2032 3 Volts
Lithium Coin Cell Battery

Pile CR2032 3 Volts
Au lithium de type "bouton"

CR2032 3 Volt
Lithium-Knopfzelle

CR2032 3 Volt
Bateria a bottone al litio

CR2032 3 voltios
Batería de litio de tipo botón

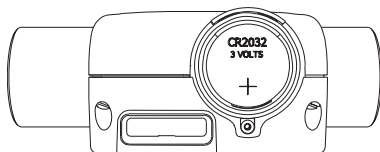

IP67 PROTECTION
PROTEZIONE IP67

PROTECTION IP67
PROTECCION IP67

IP67 - SCHUTZ

Please note the IP67 Protection rating for the instrument contained in these instructions applies to the electronics only.

La protection IP67 vaut uniquement pour l'afficheur digital.

Die IP67 Schutzkategorie gilt nur für die Elektronik.

Il grado di protezione IP67 si intende esclusivamente per l'elettronica.

La protección IP67 se aplica sólo a la unidad electrónica.

WARRANTY
GARANZIA

GARANTIE
GARANTIA

GARANTIE

Except for battery exchange only the manufacturer has the ability to dismount the electronics. Any tampering will invalidate warranty.

A l'exception du changement de pile, l'unité électronique ne peut être démontée que par le fabricant, sinon la garantie sera rendu nulle et sans effet.

Mit Ausnahme der Batteriewechsel darf die Elektronik nur vom Hersteller demontiert werden, sonst entfällt jeder Garantieanspruch.

Esclusa la sostituzione della batteria, solo il costruttore è autorizzato ad accedere all'interno dell'elettronica. Qualsiasi tentativo o manomissione farà decadere automaticamente ogni garanzia.

La garantía cubre defectos de fabricación. Las baterías no están incluidas en la misma.

Cualquier intento de manipular el equipo invalidará la garantía.

BLUETOOTH®

BRAZIL CERTIFICATION

Description of Bluetooth® Module:

This module is based on Nordic Semiconductor nRF8001 µBlue Bluetooth® Low Energy Platform. The nRF8001 is a single chip transceiver with an embedded baseband protocol engine, suitable for ultra-low power wireless applications conforming to the Bluetooth® Low Energy Specification contained within v4.0 of the overall Bluetooth specification. The nRF8001, used in the current revision of ISP091201, is a production product using a RoM for the baseband protocol engine.

Este equipamento opera em caráter secundário, isto é, não tem direito à proteção contra interferência prejudicial, mesmo de estações do mesmo tipo e não pode causar interferência a sistemas operando em caráter primário.

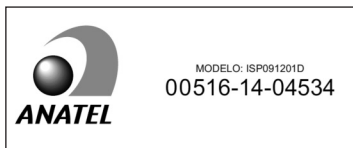

BLUETOOTH®

MEXICO CERTIFICATION

La operación de este equipo está sujeta a las siguientes dos condiciones: (1) es posible que este equipo o dispositivo no cause interferencia perjudicial y (2) este equipo o dispositivo debe aceptar cualquier interferencia, incluyendo la que pueda causar su operación no deseada.

Contiene módulo inalámbrico
Marca: Sylvac
Modelo: ISP091201D
IFT: RCPYSI14-0655

BLUETOOTH®
USA / CANADA CERTIFICATION

BOWERS
M/N: XTDU()-BT

This device contains
FCC ID: 2AAQS-ISP091201
IC: 11306A-ISP091201

NOTICE:

This device complies with Part 15 of the FCC Rules and with RSS-210 of Industry Canada. Operation is subject to the following two conditions;

- (1) this device may not cause harmful interference, and
- (2) this device must accept any interference received, including interference that may cause undesired operation.

NOTICE:

Changes or modifications made to this equipment not expressly approved by Bowers may void the FCC authorization to operate this equipment.

NOTE:

This equipment has been tested and found to comply with the limits for a Class A digital device, pursuant to Part 15 of the FCC Rules. These limits are designed to provide reasonable protection against harmful interference when the equipment is operated in a commercial environment. This equipment generates, uses, and can radiate radio frequency energy and if not installed and used in accordance with the instruction manual, may cause harmful interference to radio communications. Operation of this equipment in a residential area is likely to cause harmful interference in which case the user will be required to correct the interference at his own expense.

RADIOFREQUENCY RADIATION EXPOSURE INFORMATION:

This equipment complies with FCC radiation exposure limits set forth for an uncontrolled environment. This equipment should be installed and operated with minimum distance of 20cm between the radiator and your body.

This transmitter must not be co-located or operating in conjunction with any other antenna or transmitter.

BLUETOOTH®
SOUTH KOREA CERTIFICATION

MSIP-CRM-iNs-ISP091201

Class A Equipment (Industrial Use)

이 기기는 업무용(A급) 전자파적합기기로서 판매자 또는 사용자는 이 점을 주의하시기 바라며, 가정 외의 지역에서 사용하는 것을 목적으로 합니다.

BLUETOOTH®
JAPAN CERTIFICATION



BLUETOOTH®
TAIWAN CERTIFICATION

警語

經型式認證合格之低功率射頻電機,非經許可,公司、商號或使用者均不得擅自變更頻率、加大功率或變更原設計之特性及功能。

低功率射頻電機之使用不得影響飛航安全及干擾合法通信;經發現有干擾現象時,應立即停用,並改善至無干擾時方得繼續使用。

前項合法通信,指依電信法規定作業之無線電通信。低功率射頻電機須忍受合法通信或工業、科學及醫療用電波輻射性電機設備之干擾。



NOTES
NOTE

NOTES
NOTAS

NOTIZEN

CE

