

Replaceable Contact Point (Screw pitch M2.5 × 0.45mm)

for Dial Indicators and Linear Gauges

Replaceable Contact Point

● Ball Contact Point

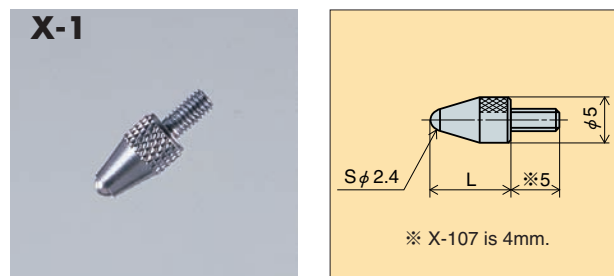

Part No.	L (mm)	Material
X-1	9	Steel
X-103	3.5	Steel
X-105	5	Steel
X-107	7.5	Steel
X-112	12.5	Steel
X-125	25	Steel
XB-1	9	Carbide
XB-115	15	Carbide
XB-125	25	Carbide
XB-130	30	Carbide
XC-1	9	Ruby
XC-125	25	Ruby

● Ball Contact Point for Oil Proof type

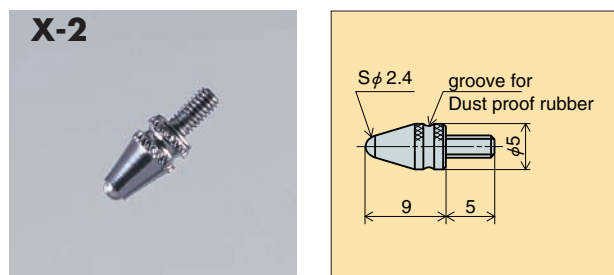

Part No.	L (mm)	Material
X-2	9	Steel
XB-2	9	Carbide
XC-2	9	Ruby
X-2A	12	Steel
XB-2A	12	Carbide

● Special Contact Point

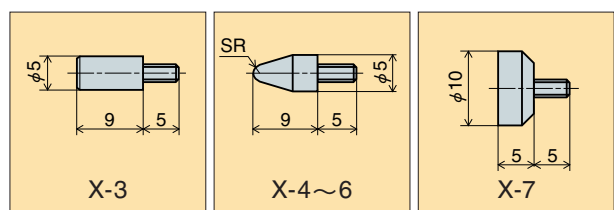

Part No.	Material
X-3	NSB
X-4	Copper
X-5	Bakelite
X-6	Teflon
X-7	Teflon

● Offset Contact Point

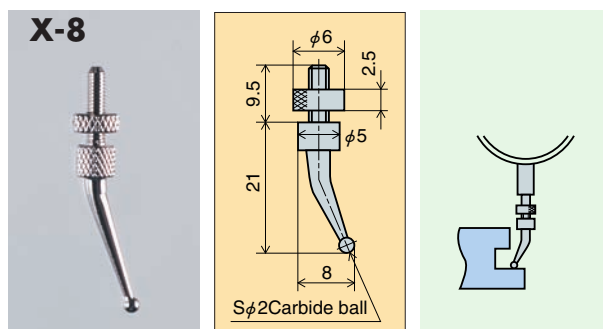

Part No.	Material
X-8	Carbide

● Special Contact Point

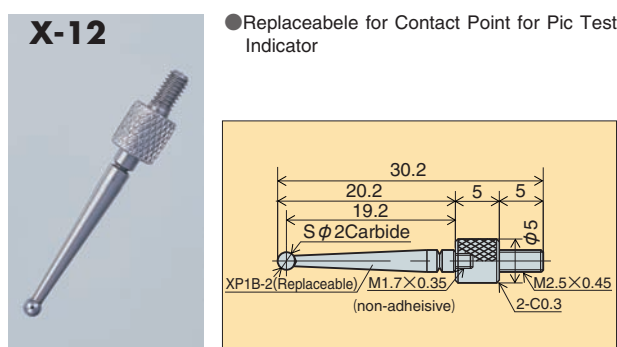

Part No.	Material
X-12	Carbide

● Spherical Contact Point



XS-1 series

Part No.	L (mm)	Material
XS-1	8	SKS3
XS-105	5	SKS3
XS-110	10	SKS3
XS-115	15	SKS3
XS-120	20	SKS3
XS-125	25	SKS3
XS-130	30	SKS3

Replaceable Contact Point (Screw pitch M2.5 × 0.45mm)

for Dial Indicators and Linear Gauges

● Flat Contact Point

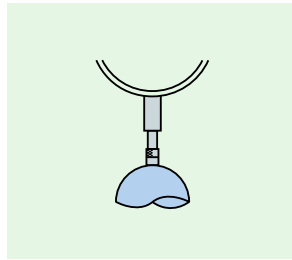
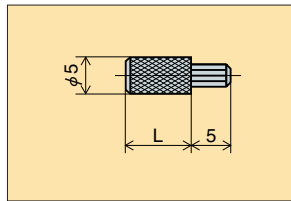

XS-2series

Part No.	L (mm)	Material
XS-2	8	SKS3
XS-205	5	SKS3
XS-210	10	SKS3
XS-215	15	SKS3
XS-220	20	SKS3
XS-225	25	SKS3
XS-230	30	SKS3

● Taper Contact Point

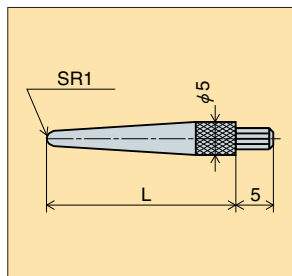

XS-3series

Part No.	L (mm)	Material
XS-3	25	SKS3
XS-310	10	SKS3
XS-315	15	SKS3
XS-320	20	SKS3
XS-330	30	SKS3

● Plain Contact Point

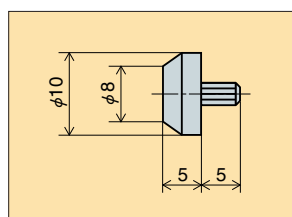

XS-4series

Part No.	Material
XS-4	SKS3

● Flat Contact Point

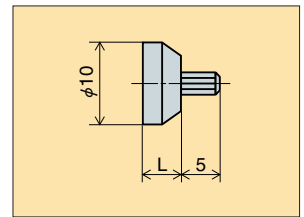

XS-5series

Part No.	L (mm)	Material
XS-5	5	SKS3
XS-510	10	SKS3

● Button type Contact Point

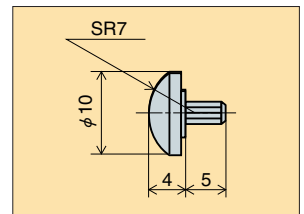

XS-6series

Part No.	Material
XS-6	SKS3

● Contact Point set XS



※XS is provided with setting table for XS-1 to XS-6 contact points, and a case. Each type sold separately.

Part No.	Material
XS	SKS3

● Knife-edge Contact Point

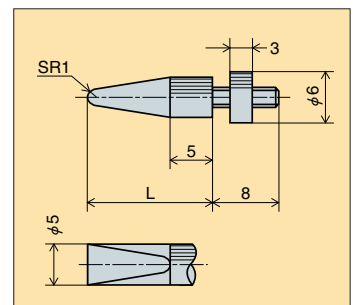

Part No.	L (mm)	Material
XS-710	10	SKS3
XS-715	15	SKS3
XS-720	20	SKS3
XS-725	25	SKS3
XS-730	30	SKS3

Replaceable Contact Point (Screw pitch M2.5 × 0.45mm)

for Dial Indicators and Linear Gauges

Replaceable Contact Point

● Carbide Spherical Contact Point

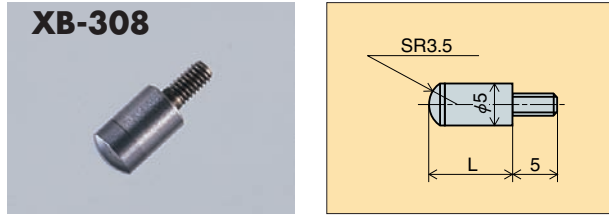

Part No.	L (mm)	Material
XB-305	5	Carbide
XB-308	8	Carbide

● Carbide Flat Contact Point



Part No.	φ D (mm)	L (mm)	Material
XB-405	5	5	Carbide
XB-406	4	6	Carbide
XB-408	5	8	Carbide

● Carbide Plain Contact Point

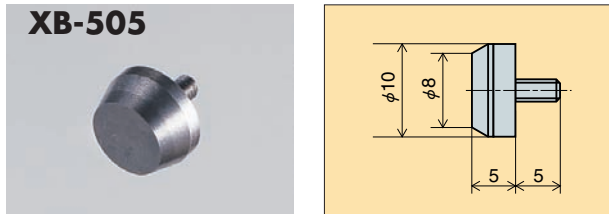

Part No.	Material
XB-505	Carbide

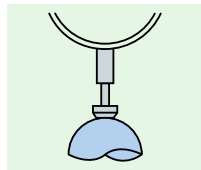

● Needle Type Contact Point

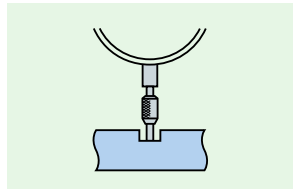
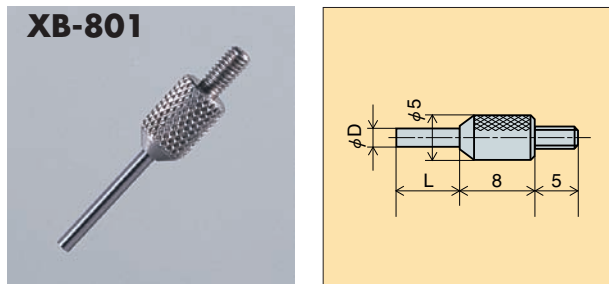

● Carbide Flat Contact Point

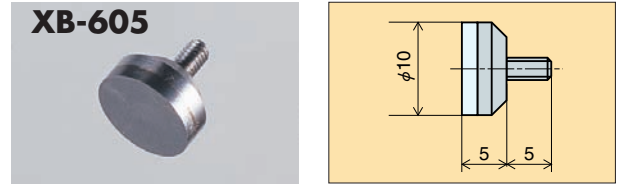

Part No.	Material
XB-605	Carbide

● Carbide Knife-edge Contact Point

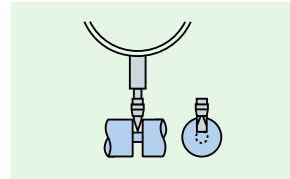
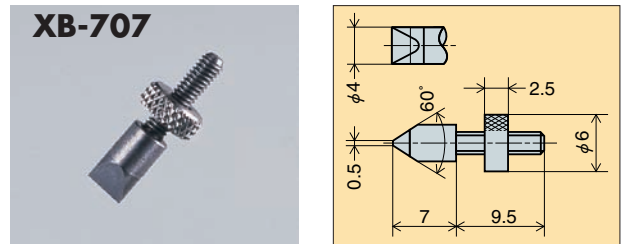

Part No.	Material
XB-707	Carbide

● Carbide Plain Contact Point

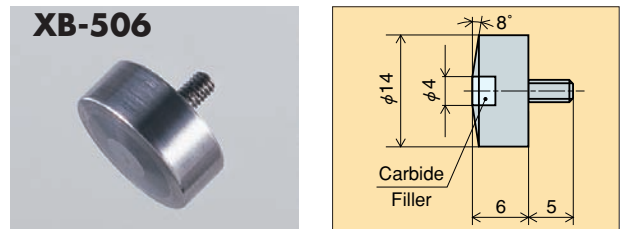

Part No.	Material
XB-506	Carbide

Part No.	φ D (mm)	L (mm)	Material
XB-800	1	2	Carbide
XB-801	1.5	12	Carbide
XB-802	2	7	Carbide
XB-803	2	12	Carbide
XB-804	1	20	Carbide
XB-805	1.5	20	Carbide
XB-806	2	20	Carbide
XB-807	1	40	Carbide
XB-808	1.5	40	Carbide
XB-809	2	40	Carbide

Part No.	φ D (mm)	L (mm)	Material
XS-800	1	2	SKS3
XS-801	1.5	12	SKS3
XS-802	2	7	SKS3
XS-803	2	12	SKS3
XS-804	1	20	SKH
XS-805	1.5	20	SKH
XS-806	2	20	SKH
XS-807	1	40	SKH
XS-808	1.5	40	SKH
XS-809	2	40	SKH

Replaceable Contact Point (Screw pitch M2.5 × 0.45mm)

for Dial Indicators and Linear Gauges

1

Replaceable Contact Point

● Needle Contact Point

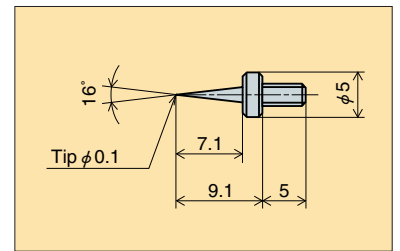
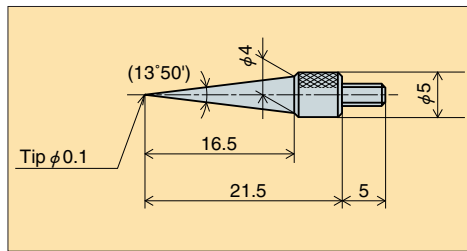
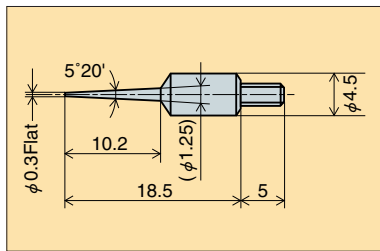

Part No.	Material
XT-2C	SK 3

Part No.	Material
XT-3	SK 3

Part No.	Material
XT-4	SK 3

● Needle Contact Point

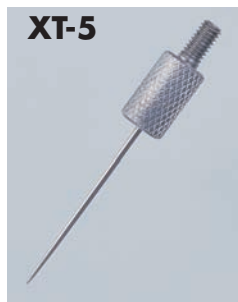

Part No.	Material
XT-5	sewing needle

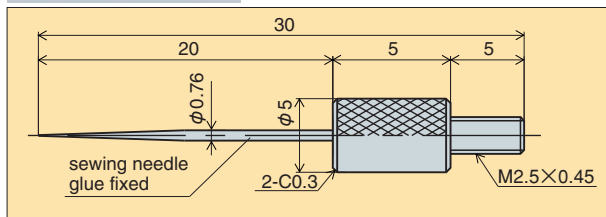

● Roller Contact Point

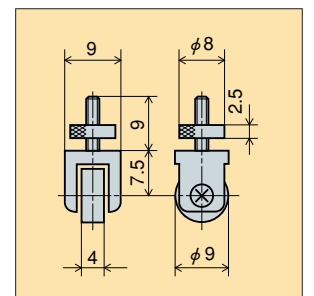
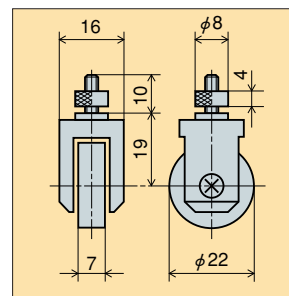
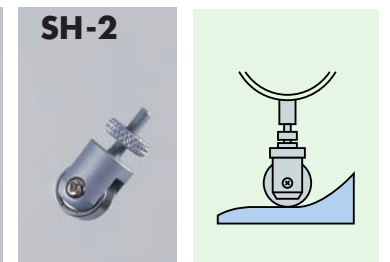

Part No.	Material
SH-1	SUJ2

Part No.	Material
SH-2	SUJ2

● Contact Point Joint

To extend the contact point, simply add the contact point joint.

L (mm)	φ 4 type	φ 5 type
6	XJ-406	
10	XJ-410	XJ-510
15	XJ-415	
20	XJ-420	XJ-520
25	XJ-425	
30	XJ-430	XJ-530
35	XJ-435	
40	XJ-440	XJ-540
45	XJ-445	
50	XJ-450	XJ-550
55	XJ-455	
60	XJ-460	XJ-560
65	XJ-465	
70	XJ-470	
75	XJ-475	
80	XJ-480	
90	XJ-490	
100	XJ-400	

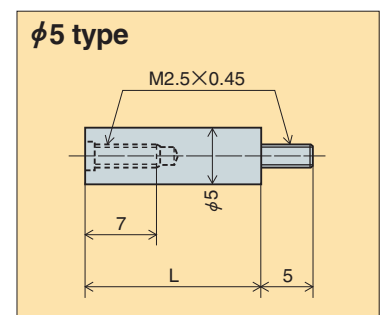
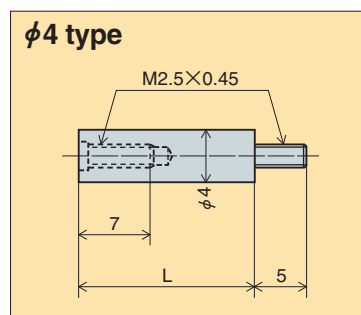

Length of the thread screw of XJ-406 is 5mm.